

ECC9312K  
ECC9310S  
ECC9232K

Electrolux Range Hood

User Manual





## Contents

1. Product Description .....	3	7. Instructions for Use .....	8
2. Precautions .....	3	8. Maintenance .....	12
3. Packing List .....	4	9. Troubleshooting .....	13
4. Technical Specifications .....	4	10. Part Names .....	14
5. Schematic Circuit Diagram .....	5	11. Customer care center .....	17
6. Installation Instructions .....	5		

## Customer Care and Service

The following symbols will be used in this manual, with their explanations as follows:

-  Warning! Important information relating to protection of personal safety and avoidance of electrical damage.
-  General information and advice
-  Environmental protection information

## 1. Product Description

The romantic European range hood has the following six advantages:

1. Futuristic design, up-to-date styling  
Streamlined design, elegant and stylish appearance, and touch control, fully showing the cooking experience of blues style.
2. Large suction and complete removal of fume  
The integral stretched hood is more suitable for the fume collection area of kitchens, and the fan with a large exhaust rate is used to exhaust fume more thoroughly.
3. Low noise  
According to the principle of aerodynamics, the well-designed exhaust system guarantees smooth and quiet operation.
4. Easy maintenance  
Large conical strainers for air intake are designed on four sides to ensure thorough fume suction, avoid spillage of residual oil, and smoothly converge residual oil into the oil cup, while avoiding the weakness in the maintenance of traditional European range hoods.
5. Circuit characteristics  
A unique multi-circuit design is used to ensure no accumulation, no dripping, or seepage.

## 2. Precautions

### (1) Child Safety



1. Do not allow children to extend their fingers or other parts of the body into the range hood.  
Warning: Destroy or recycle the appliance's carton, plastic bags, and any other exterior wrapping material immediately after the product is unpacked. Children should never play with these items. Danger of suffocation!

### (2) Precautions for Use



1. Always use a power supply compliant with the requirements of the appliance. A three-pin power socket must be reliably grounded.



2. The wall on which the range hood will be installed should be strong enough to bear the dead weight of the range hood itself. The wall must be non-combustible.



3. Do not expose the range hood to fire directly.



4. Protect the motor, switches and other electrical parts against water.



5. Do not change the specifications of electrical parts, change the internal circuit, or connect other lines.



6. Do not scratch, knot, or squeeze the power cable.



7. If any abnormal conditions occur during use, refer to the troubleshooting section for solutions before contacting the customer service centre. If the fault persists, unplug the power plug of the range hood and contact our customer service centre.



8. If the light is damaged, replace it with a new one with the same specifications.



9. This appliance is for household use only instead of unintended purposes.



10. When oil residue stored in the oil cup reaches two thirds of its capacity, clean immediately to prevent spillage.



11. Do not dismantle and repair the appliance without authorization. Otherwise, serious consequences may be followed.



12. If users do not clean the range hood according to the instructions, there is a risk of fire.

**i** 13. The room must be well-ventilated when the range hood is used in a place where gas or other fuel is combusted (but the range hood should not be installed in a place with large convection. Otherwise, the suction performance will be degraded).

**i** 14. The gas discharged from the range hood cannot be discharged into the waste smoke tube of burning gas or other fuels.

(3) Environmental Protection

"Environmental protection, benefit of mankind, pollution prevention, and continuous improvement" are the philosophy our company's environmental management. The environmental impact caused by our products in use and after service life is hereby warned to you as follows:



Waste cartons and plastic bags are recyclable while waste foam is not. Properly classify these wastes after unpacking.

### 3. Packing List

Please check the items in the package against the packing list. If there is any missing or lost item:

1. Please ask the vendor to handle this if it is the responsibility of the company or vendor.
2. Please contact the vendor or the company if it is your responsibility.

S/N	Name	Qty	S/N	Name	Qty
1	Appliance	1 set	8	Smoke tube adapter	1 pcs
2	User manual	1 pcs	9	Decorative cover mounting plate	One ECC9310S
3	Warranty card	1 pcs			One ECC9312K
4	Oil cup	1 pcs			Two ECC9232K
5	Appliance mounting plate	1 pcs	10	Special screws for decorative cover, safety block, ST5X19 screws, expansion tube, and wood screws	1 bag
6	Air outlet	1 pcs			
7	Aluminium foil tube	1 pcs			

### 4. Technical Specifications

Model	ECC9310S	ECC9312K	ECC9232K
Outline dimension (mm)	Length 895 × width 485 × height (Min. 667 mm/Max. 979 mm)	Length 895 × width 485 × height (Min. 667 mm/Max. 979 mm)	Length 895 × width 470 × height (Min. 643 mm/Max. 955 mm)
Net weight (kg)	25.5	24	23
Power supply (W)	220 V-240 V-/50 Hz	220 V-240 V-/50 Hz	220 V-240 V-/50 Hz
Rated total input power (W)	295	215	223
Motor input power (W)	293	213	220
Lighting power (W)	2 W × 1	2 W × 1	1.5 W × 2

## 5. Schematic Circuit Diagram

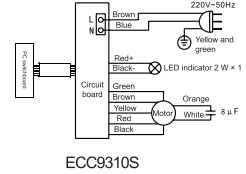
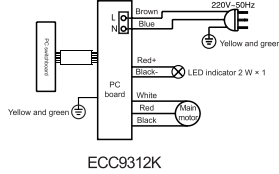
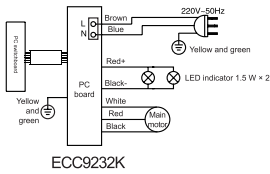

## 6. Installation Instructions

### I. Installation Requirements

1. The wall on which the appliance is installed should be strong enough to bear the dead weight of the appliance.
2. The range hood must not be in contact with the electrical lines inside and outside the wall. Otherwise, there is a risk of electric shock.
3. The range hood should not be installed in a place with large convection. Otherwise, the suction performance will be degraded.
4. The range hood should be securely installed on the wall 650 mm above the cooker. The lower the height, the better the suction performance.
5. The distance between the air outlet of the range hood and the upper exhaust hole should be less than or equal to 1.5 m, so as to avoid degraded suction performance because of too long air outlet or too many turns (generally one turn).
6. The following figure shows the installation dimension of the air outlet when it is mounted to the cupboard or ceiling.

### II. Installation Method

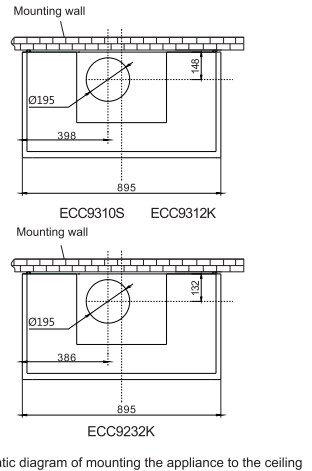
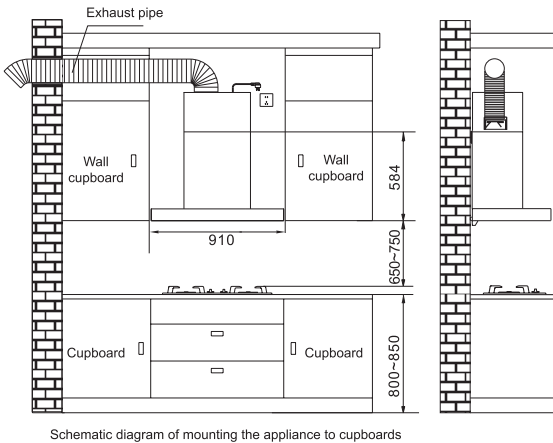

- (1) The distance from the bottom of the range hood to the cookware supporting surface on the stove should be at least 650mm. If the installation instructions of gas stove specify a greater distance, it should be considered.
- (2) Identify the hole location, drill two holes with a diameter of 10 mm, a depth of 53 mm and a spacing of 180 mm on the wall, and bury the expansion pipes in the holes.

- (3) Secure the mounting plate to the wall with two  $\varnothing 5 \times 53$  mm wood screws.  
Note: Avoid electric wires inside the wall while drilling. Otherwise, there is a risk of electric shock.
- (4) Remove the eight self-tapping screws from the air outlet assembly using a Phillips screwdriver, and remove the rubber gasket.
- (5) Place the rubber gasket and air outlet assembly onto the air outlet in turns, and align them with the screw holes. After the screw holes are aligned, secure the rubber gasket and air outlet assembly to the mainframe using the eight self-tapping screws removed in Step 1.
- (6) By referring to the figure, remove the smoke tube and short adapter (both have been secured with aluminium foil tape) (the smoke tube and adapter are accessories, not in the product package) so that the smoke tube is compressed. Pass the air outlet cover from top to bottom through the smoke tube and short adapter to the end. Then fasten and interlock the above assembly to the air outlet seat with the four buckles on the air outlet cover. Connect the power supply, start the motor, and check whether the two metal pieces turn up. The two metal pieces should fall back naturally when the appliance is turned off.
- (7) Lift the appliance, align the hanging holes on the back of the mainframe with the hooks on the mounting plate, and check that the appliance is installed horizontally and stably.  
Use one screw (ST5x19) to fix the appliance block on the wall through the plastic expansion pipe to prevent the appliance from falling off in the vertical direction when it is subjected to external forces.
- (8) Direct connection is possible when the aperture of the smoke outlet on the kitchen wall is larger than the outer diameter of the exhaust pipe. Otherwise, cut off the excess part of the exhaust pipe connector smaller than the smoke outlet as required, connect the exhaust pipe and exhaust pipe connector with adhesive tape, and install it into the smoke outlet.
- (9) If you connect the exhaust pipe directly to the outside, extend the exhaust pipe at least 30 mm out of the wall, with the air outlet slightly tilting down to avoid backflow of rainwater.
- (10) To install a decorative cover, determine the position of the mounting hole of the decorative cover mounting plate according to the installation diagram.
- (11) (ECC9310S/ ECC9312K): Drill two holes with a diameter of 10 mm and a depth of 50 mm with an electric impact drill at the corresponding positions, bury plastic expansion pipes, and fix the upper decorative cover bracket on the wall with two screws ( $\varnothing 5 \times 53$ ).  
(ECC9232K): Drill four holes with a diameter of 10 mm and a depth of 50 mm with an electric impact drill at the corresponding positions, bury plastic expansion pipe, and fix the two upper decorative cover brackets on the wall with four screws ( $\varnothing 5 \times 53$ ).
- (12) (ECC9310S/ ECC9312K): Pull out the upper decorative cover, adjust the height of the upper decorative cover and hook it to the mounting hole. Align the holes on both sides of the upper decorative cover with the anchor holes of the bracket, and secure them with two stainless steel screws (M4  $\times$  12) with gaskets. (Note: Be careful while pulling out the upper cover and pay attention to sharp edges around the product to avoid cuts.)  
(ECC9232K): Pull out the upper decorative cover, adjust the height of the upper decorative cover and hook it to the mounting hole. Align the holes on both sides of the upper decorative cover with the anchor holes of the bracket, and secure them with four stainless steel screws (M4  $\times$  12) with gaskets. (Note: Be careful while pulling out the upper cover and pay attention to sharp edges around the product to avoid cuts.)  
Align the hanging lugs at both ends of the oil cup with the slots on the two oil cup brackets at the lower end of the rear of the range hood, push the oil cup horizontally inward, and check that the oil cup is securely installed.

Hole 4 - Ø10 (for mounting the decorative cover mounting plate)  
 285 Linear distance < 1200

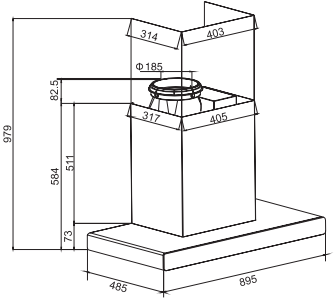
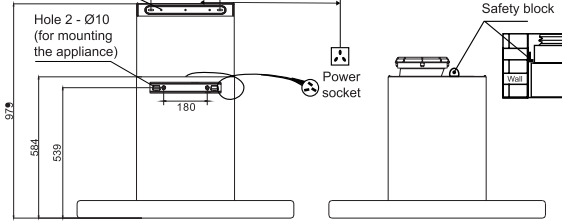

ECC9310S/ ECC9312K

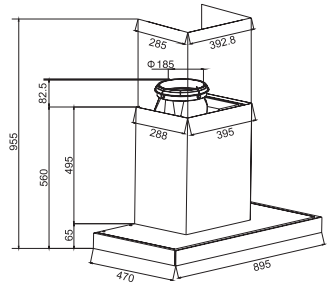
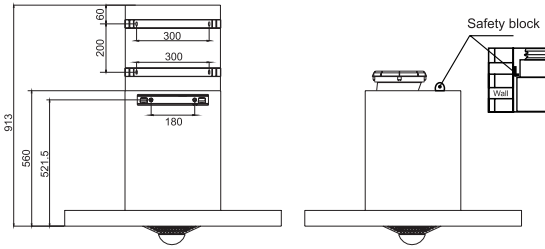

ECC9232K

### III. Installation Checks

The user should first check whether the range hoop is well installed.

### IV. Power Settings

After checking that the appliance is properly installed, plug the power plug of the appliance into a power socket that is reliably grounded.

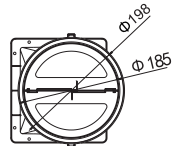

Installation range of smoke pipe: Inner diameter greater than Ø185, outer diameter smaller than Ø198

## 7. Instructions for Use

### 1. The instructions for use of the Power button of ECC9310S



#### Power ●

When you tap the "Power" button, the buzzer sounds and all buttons are lit up in white. The red LED indicator lights turn on from left to right for 0.1 seconds. In the final 0.6 seconds, if there is a speed setting memory, the fan is turned on in the memorized speed setting. Otherwise, the fan is turned on in speed 2 when the appliance is on, and the red power indicator light and red indicator lights for the corresponding speed setting and lower speed setting are turned on.

With power on, when you tap the "Power" button, the buzzer sounds, all the buttons are turned off, and the appliance is turned off (The light is not affected).

#### Fan Speed Settings

With power on, you can tap the "1", "2" or "3" button to set the fan speed with a beep sound. The indicator light for the fan speed button you tap and the indicator lights with lower speed setting are displayed in red. You can switch fan speed freely among "1", "2" and "3" by tapping the fan speed key.

#### Stir-fry 🌀

With power on, when you tap the "Stir-fry" button, the buzzer sounds, and the red indicator lights for the fan speed and the button will be displayed. The fan will return to the original speed setting after the speed setting in stir-fry mode runs for 1 minute. When you tap the "Stir-fry" button again within 1 minute, the fan will restore its original speed setting with a beep sound. Directly press other speed setting buttons to enter the corresponding speed setting.

#### Light 🌟

In standby/on state, when you tap the "Light" button, the buzzer sounds, the Light button is lit up, the corresponding red indicator light is lit up, and the light turns on. You can tap the "Light" button again to turn off the indicator light and the light.

#### Delay Shutdown ⏸

With fan on, when you tap the "Delay" button, the buzzer sounds, the red indicator light for the Delay button blinks, and the system starts to execute the "Delay Shutdown" function. The fan runs in speed setting 1 and the red indicator light for speed setting 1 turns on. The appliance shuts down after 5 minutes. You can tap the "Delay" button again in "Delay Shutdown" mode to disable the delay shutdown function. Upon completion of delay shutdown, the appliance is shut down and the light turns off.

#### Strainer Clean ●

After the appliance is powered on for the first time, the system will accumulate the operation time of the appliance. When the operation time reaches 50 hours, the red indicator light for the Clean button will blink. Users need to remove the strainer for cleaning. Press and hold the "Strainer Clean" button for 3 seconds after the strainer is reinstalled to clear the alarm (The 50-hour timer starts again).

### 2. The instructions for use of the Power button of ECC9312K

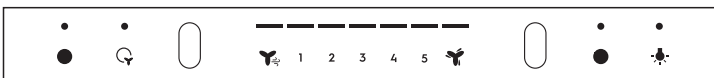



## Power ●

When you tap the "Power" button or wave your hand right, the buzzer sounds and all white button indicator lights are lit up. The red LED indicator lights turn on from left to right for 0.1 seconds. In the last 0.6 seconds, if there is a speed setting memory, the fan is turned on in the memorized speed setting. Otherwise, the fan is turned on in speed 2, and the red power indicator light, the red indicator light for the corresponding speed setting, and the ventilation indicator light are turned on. The appliance is powered on.

With power on, when you tap the "Power" button, the buzzer sounds, all the buttons are turned off, and the appliance is turned off. The flap at the air inlet is closed.

## Fan Speed Settings

With power on, you can tap the "1", "2", "3", "4", or "5" button or wave your hand left or right to set the fan speed with a beep sound. The indicator light for the fan speed button you tap, the ventilation indicator light, and the indicator lights with lower speed setting are displayed in red. You can switch fan speed freely among "1", "2", "3", "4", and "5" by tapping the fan speed key.

## Stir-fry 🍳

With power on, when you tap the "Stir-fry" button, all the speed settings are displayed. The fan will return to the original speed setting after the speed setting in stir-fry mode runs for 1 minute. When you tap the "Stir-fry" button again within 1 minute, the fan will restore its original speed setting with a beep sound.

## Ventilation 🌬️

With power on, when you tap the "Vent" button, the ventilation function is enabled, and the red indicator light for the button blinks. The fan runs for 5 minutes in speed setting 1 every one hour. You can tap the "Vent" button again or swipe right to cancel ventilation. The fan starts in speed setting 2. You can tap the "Power" button or swipe left to shut down the appliance.

## Light 💡

In standby/on state, when you tap the "Light" button, the buzzer sounds, the Light button is lit up, the corresponding red indicator light is lit up, and the light turns on. You can tap the "Light" button again to turn off the indicator light and the light.

## Delay Shutdown ⏸️

With fan on, when you tap the "Delay" button or control the appliance with gesture, that is, swiping left in speed setting 1, the buzzer sounds, the red indicator light for the Delay button blinks and the red indicator light for speed setting 1 turns on, and the system starts to execute the "Delay Shutdown" function. The fan runs in speed setting 1 and stops after 5 minutes. You can tap the "Delay" button again in "Delay Shutdown" mode to disable the delay shutdown function. Upon completion of delay shutdown, the appliance is shut down and the light turns off.

## Strainer Clean ●

After the appliance is powered on for the first time, the system will accumulate the operation time of the appliance. When the operation time reaches 50 hours, the red indicator light for the Clean button will blink. Users need to remove the strainer for cleaning. Press and hold the "Strainer Clean" button for 3 seconds after the strainer is reinstalled to clear the alarm (The 50-hour timer starts again).

## Gesture Settings

With power off, press and hold the "Power" button for 3 seconds to enter the gesture setting mode. Tap the "1" button. The red indicator light turns on and the gesture function is enabled. Tap the "2" button. The red indicator light turns on and the gesture function is disabled. In gesture setting mode, if you tap the

"Power" button or "Light" button, or the appliance is inactive for 3 seconds, the appliance is turned off and the gesture function is set (The gesture function is enabled by default).

### Gesture Function

When the appliance is turned off, if you wave your hand left, the appliance remains off without response. You can wave your hand right to start the appliance. The appliance starts in speed setting 2 for the first time. The appliance will start in the last speed setting in later uses (not ventilation or delay mode).

When the appliance is operating, you can wave your hand left to reduce speed setting from stir fry, 5, 4, 3, 2, 1, delay shutdown to shutdown, or wave your hand right to increase speed setting from 1, 2, 3, 4, 5 to stir fry, and then maintain at the stir fry mode without other response.

When the delay shutdown function is enabled, you can wave your hand left to shut down the appliance, or wave your hand right to start the appliance in speed setting 2.

When the ventilation function is enabled, you can wave your hand left to shut down the appliance, or wave your hand right to start the appliance in speed setting 2.

In gesture setting mode, the appliance does not respond when you wave your hand left or right.

### 3. The instructions for use of the Power button of ECC9232K



#### Off State

With power off, all white button indicator lights are turned off.

You can tap the "Light" button to turn on the light and tap the button again to turn off the light. The related white button indicator light will be steadily on when the light is turned on.

You can tap the Power button to start the appliance. If a speed has been set, the fan starts in the speed setting. Otherwise, the fan starts in speed setting 2. The Power, +/-, Light, and Stir-fry buttons are steadily on, and the Nixie tube displays corresponding numeric values (Note: "b" is displayed for "Stir-fry").

#### On State

With power on, the Power, +/-, and Stir-fry buttons are steadily on, and the Nixie tube displays the corresponding speed setting. The status of other button indicators depends on the status of corresponding functions.

You can tap the "Light" button to turn on the light and tap the button again to turn off the light. The related white button indicator light will be steadily on when the light is turned on.

If the appliance operates for 50 hours, the white cleaning indicator light blinks. In this case, press and hold the Clean button for 3 seconds. The white button indicator light turns off, the accumulated time is cleared, and the timer starts again.

When you tap the + button, if the current speed setting is lower than 5, the speed is increased. Otherwise, the speed setting remains unchanged.

When you tap the - button, if the current speed setting is greater than 1, the speed is reduced. Otherwise, the speed remains unchanged.

When you tap the Power button, the appliance is shut down, and the status of the light is not affected.

When you tap the Stir-fry button, the appliance runs in Stir Fry mode for one minute. The original speed setting resumes after one minute or when you tap the button again. The appliance does not respond if you tap the + button within one minute. When you tap the - button, the speed setting 5 is enabled.

With power on, you can tap the Power button to turn off the appliance, and the status of the light is not affected.

Removal of the light:

(1) Removal of the light for CC9232K:

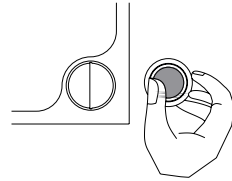
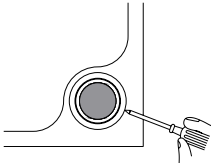

1. Extend a small slotted screwdriver or similar objects into the gap between the light cover and the hood.
2. Pry up the light from the hood and disconnect the connector. The light can be replaced.

(2) Removal of the light for ECC9310S/ ECC9312K:

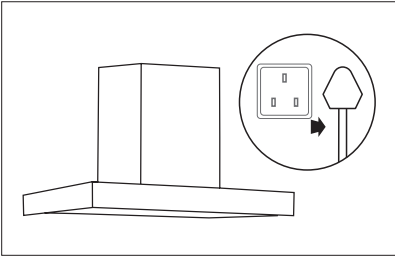

1. Remove the power plug

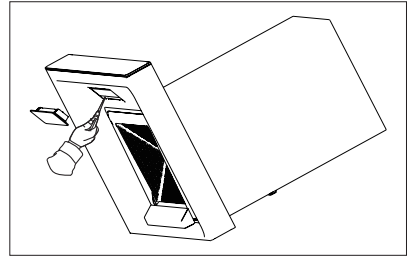

2. Pry up the light with a small slotted screwdriver and remove it, and then replace it with a new light of the same specifications.

Removal of the switch:

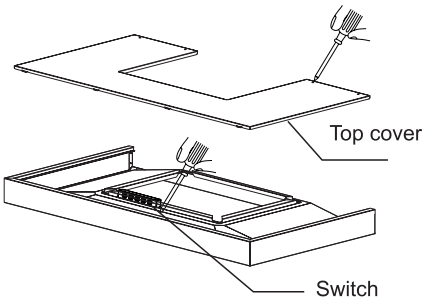

Unscrew the top cover in the upper part of the mainframe (as shown in the figure) with a screwdriver to remove the top cover. Then, unscrew the switch with a screwdriver and remove the switch.

## 8. Maintenance

Maintenance guarantees good performance. Please take good care of your appliance.  
 Be sure to cut off the power supply before any maintenance operations (hold the plug and remove it).  
 Perform maintenance operations with gloves to prevent cuts by sharp edges of the appliance.  
 Remove oil stains on the surface of the strainer and mainframe regularly, and keep the appliance clean.  
 Clean the strainer every month to ensure good suction and exhaust performance.  
 Perform total preventive maintenance every year to clean oil stains and guarantee good performance.  
 Do not clean the appliance with water or flammable cleaning agent.

### Removal of Parts

Handle with care while disassembling parts to avoid distortion or damage.

- (1) Hold the oil cup and pull it out horizontally.
- (2) Remove the screws securing the strainer and remove the strainer.
- (3) Remove the screws securing the external decorative cover (on the rear) and remove the decorative cover.
- (4) Remove the screws securing the case cover and remove the case cover.
- (5) Remove the screws securing the guide ring and remove the guide ring.
- (6) Remove the wind wheel cap in the direction as indicated by the arrow and remove the wind wheel.
- (7) After maintenance operations, reinstall parts in the reverse order of removal.

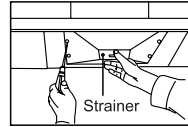

ECC9232K

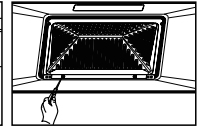

ECC9310S  
ECC9312K

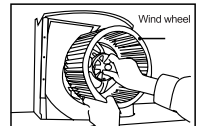
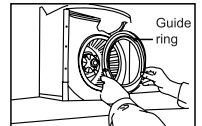
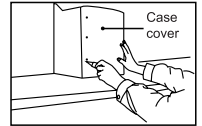
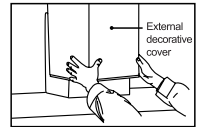

### Cleaning of Parts

- (1) Please use neutral detergent, soft cloth and soft brush for cleaning parts. Do not use organic solvents.
- (2) Please soak parts for 30 minutes before cleaning. Avoid deformation or damage during cleaning.
- (3) Upon completion of part cleaning, rinse parts with fresh water and wipe dry with a soft cloth.
- (4) Use a soft dry cloth or soft brush to clean the electrical parts, instead of water or detergent.
- (5) If users do not clean the appliance according to the instructions, there may be a risk of fire.

Note: The range hood should be maintained by skilled personnel.

## 9. Troubleshooting

- Always remove the power plug before troubleshooting

Problem	Possible Cause	Solution
Both the light and motor do not work	The power plug is not properly connected	Connect the power plug properly
	No power output	Ask an electrician for help
The motor works but the light is not lit up	The light is damaged	Replace with a new light (Please contact our customer service centre for door-to-door service)
	The PC board is damaged	Replace with a new PC board (Please contact our customer service centre for door-to-door service)
The light works but the AC motor does not work	The capacitor has poor contact or is damaged	Please contact our customer service centre for door-to-door service
	The motor is damaged or the power board is damaged	Please contact our customer service centre for door-to-door service
The running wind wheel is noisy	The wind wheel is loose and the cap is not tightened	Tighten the cap
Speed setting 1 is unavailable Other speed settings are available	The control switch is faulty	Replace with a new switch (Please contact our customer service centre for door-to-door service)
Poor suction performance	Too high installation height	Reduce the installation height
	Two wind screens are not completely opened	Check that wind screens should be flexibly rotated
	Too large convection around the appliance	Close doors and windows if applicable
	Too much oil stain	Clean oil stain
	Maximum speed is not set	Set to the maximum speed
The DC motor does not work	The main power board does not communicate information to the motor	Replace with a new PC board (Please contact our customer service centre for door-to-door service)

### **Warning:**

1. Please cut off the power supply before connecting or replacing plug-ins.
2. A damaged power cable must be replaced by a skilled person from the manufacturer, its repair department or other similar departments.
3. Do not suck flame into the appliance. Otherwise, there may be a risk of fire.

# 10. Part Names

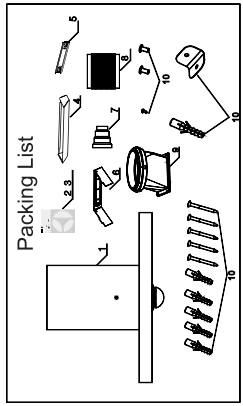
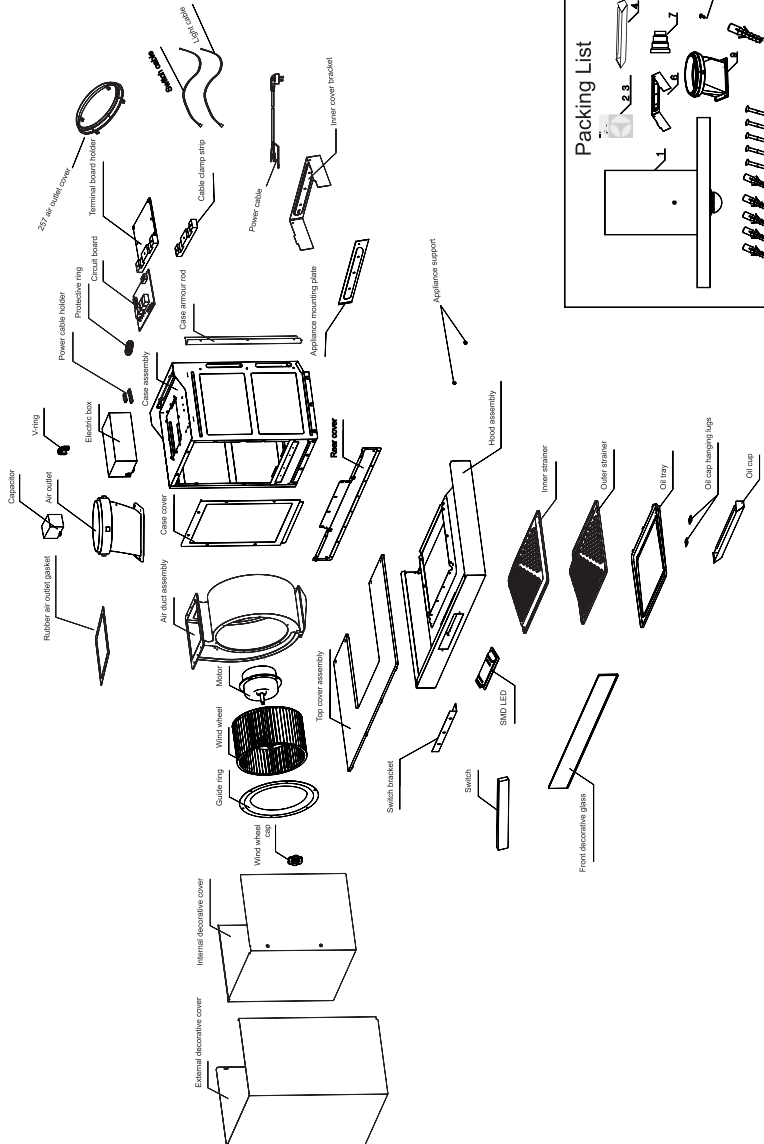



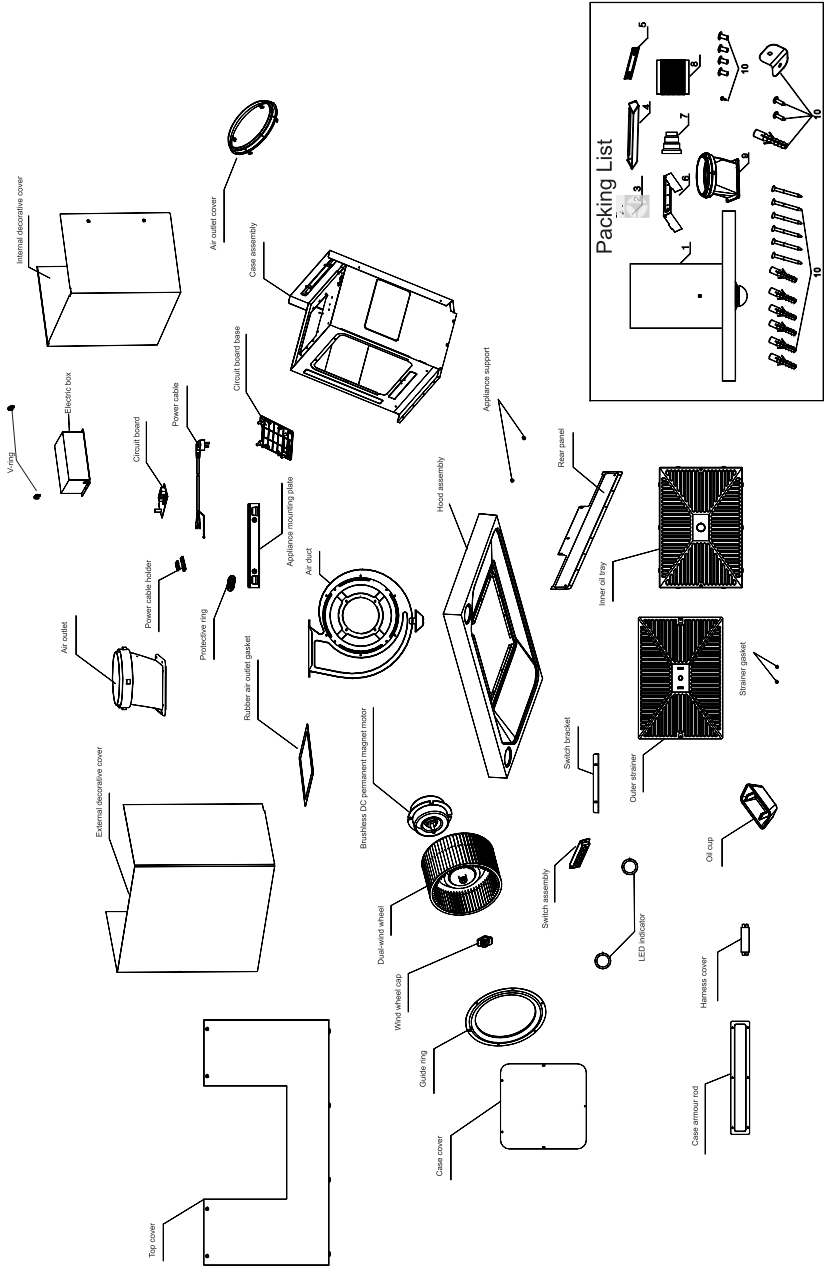

ECC9232K



## CONSUMER CARE CENTER

<p>Thailand  Consumer Care Tel : (+66 2) 725 9000  Electrolux Thailand Co., Ltd.  Electrolux Building 14th Floor  1910 New Phetchaburi Road,  Bangkapi, Huai Khwang, Bangkok 10310  Office Tel : (+66 2) 7259100  Office Fax : (+66 2) 7259299  Email : customercarethai@electrolux.com</p>	<p>Singapore  Consumer Care Center Tel: (+65) 6727 3699  Electrolux S.E.A. Pte Ltd.  351 Braddell Road  #01-04, 351 On Braddell  Singapore 579713  Email : customer-care.sin@electrolux.com</p>
<p>Indonesia  Hotline service: 08041119999  PT. Electrolux Indonesia  Electrolux Building  Jl.Abdul Muis No.34, Petojo Selatan,  Gambir Jakarta Pusat 10160  Email:customercare@electrolux.co.id  SMS &amp; WA : 0812,8088,8863</p>	<p>Philippines  Consumer Care Center Toll Free:  1-800-10-845-CARE(2273)  Consumer Care Hotline:(+63 2)845-CARE(2273)  Electrolux Philippines,Inc.  Unit B 12F Cyber Sigma Bldg, Lawton Avenue,  McKinley West,Taguig, Philippines 1634  Trunkline:+63 2 737-4757  Website:www.electrolux.com.ph  Email:wecare@electrolux.com</p>
<p>Vietnam  Consumer Care Center Toll Free  1800-58-88-99  Tel: (+84 28) 39105465  Electrolux Vietnam Ltd.  Unit 1&amp;2, 10F Sofic Tower, #10 Mai Chi Tho  Street,  Thu Thiem Ward, Thu Duc City, Ho Chi  Minh City, Vietnam</p>	<p>Malaysia  Consumer Care Center Tel: 1300-88-11-22  Electrolux Home Appliances Sdn. Bhd.  Corporate Office Address: Unit T2-7, 7th Floor,  Tower 2, PJ33, No. 3, Jalan Semangat,  Seksyen 13, 46200 Petaling Jaya, Selangor.  Office Tel : (+60 3) 7843 5999  Office Fax : (+60 3) 7955 5511  Consumer Care Center Address: Lot C6, No. 28,  Jalan 15/22, Taman Perindustrian Tiong Nam,  40200 Shah Alam, Selangor  Consumer Care Center Fax : (+60 3) 5524 2521  Email : malaysia.customercare@electrolux.com</p>
<p>HONG KONG  SERVICE HOTLINE: (+852) 3193 9888  DCH ELECTRICAL APPLIANCES  SERVICE CENTRE  4/F, DCH BUILDING, 20 KAI CHEUNG  ROAD,  KOWLOON BAY, HONG KONG  EMAIL: customercare@dch.com.hk  WEBSITE: www.electrolux.com.hk</p>	

**[www.electrolux.com](http://www.electrolux.com)**

**The Thoughtful Design Innovator.**

Do you remember the last time you opened a gift that made you say, “Oh! How did you know? That’s exactly what I wanted!” That’s the kind of feeling that we at Electrolux seek to evoke in everyone who chooses or uses one of our products. We devote time, knowledge, and a great deal of thought to anticipating and creating the kind of appliances that our customers really need and want.

This kind of thoughtful care means innovating with insight. Not design for design’s sake, but design for the user’s sake. For us, thoughtful design means making appliances easier to use and tasks more enjoyable to perform, freeing our customers to experience the ultimate 21st century luxury: ease of mind. Our aim is to make this ease of mind more available to more people in more parts of their everyday lives, all over the world.

The “Thinking of you” promise from Electrolux goes beyond meeting the needs of today’s consumers. It also means we’re committed to making appliances safe for the environment—now and for future generations.

Electrolux. Thinking of you.

Share more of our thinking at  
**[www.electrolux.com](http://www.electrolux.com)**



Version No.: MU-H-202112