

EQACF01SXWT



EN

USER MANUAL

1

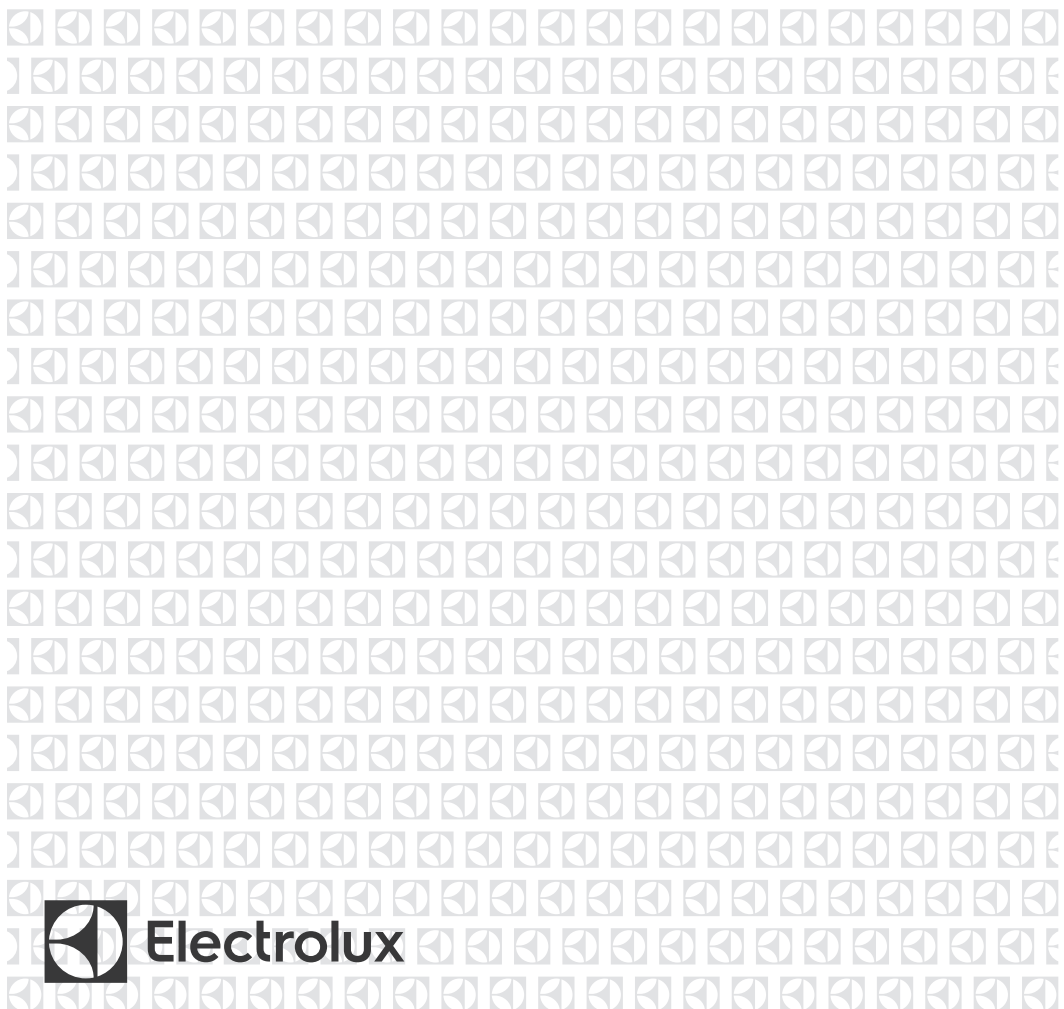

Electrolux

Welcome

Thank you for choosing Frigidaire.

Our water dispensers are developed with high technical and quality standards, with features to offer you even more comfort.

Read all instructions before using this appliance. This book contains valuable information about operation, care and service. Keep it in a safe place.

You expect all this from Frigidaire....and we deliver.

Environmental advice

The packaging material used is recyclable; we recommend that you separate plastic, paper and cardboard and give them to recycling companies.

According to WEEE (Waste of Electrical and Electronic Equipment) guidelines, waste from electrical and electronic devices should be collected separately.

If you need to dispose of this appliance in the future, do NOT throw it away with the rest of your domestic garbage.

Instead, please take the appliance to the nearest WEEE collection point, where available.

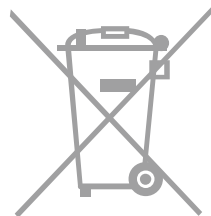

Attention

Inside you will find many helpful hints on how to use and maintain your water dispenser properly. Just a little preventive care on your part can save you a great deal of time and money over the life of your air conditioner. You'll find many answers to common problems in the chart of troubleshooting tips. If you review our chart of Troubleshooting Tips first, you may not need to call for service at all.

Contents

Safety	3
Product description	5
Installation	6
How to use	9
Care and cleaning	11
Troubleshooting	13
Technical informations	15

Attention

- The appliance that you have bought may be slightly different from the one illustrated in this manual. Please refer to the information related to the model you have.
- The appliance you have may carry a different plug than the one illustrated in this manual. The plug that comes with the product follows the electrical specification of the country where it is sold.
- Contact the authorised service technician for repair or maintenance of this unit.
- If the power cord is to be replaced, replacement work shall be performed by authorised personnel only.
- This product was developed for regions with an altitude of approximately 2000 meters. For a higher region, the water boiling point might be too low and cause product damages.

Safety

To reduce risk of injury and property damage, user must read this entire guide before assembling, installing and operating dispenser.

Failure to execute the instructions in this manual can cause personal injury or property damage.

This product dispenses water at very high temperatures. Failure to use properly can cause personal injury.

When operating this dispenser, always exercise basic safety precautions, including the following:

For children

- This appliance can be used by children aged from 8 years and above and persons with reduced physical, sensory or mental capabilities or lack of experience and knowledge only if they have been given supervision or instruction concerning using the appliance in a safe way and understanding the hazards involved.
- Do not let children play with the appliance.
- Keep all packaging items away from children.
- If the appliance has a child safety device, we recommend you activate it.
- Cleaning and user maintenance shall not be made by children without supervision.
- Children of less than 8 years should be kept away unless continuously supervised.

General safety

- It is most important that this instruction book should be retained with the appliance for future reference. Should the appliance be sold or transferred to another owner, or should you move to another house and leave the appliance, always ensure that the book is supplied with the appliance in order that the new owner can get to know the functioning of the appliance and the relevant warnings.
- Correct functioning of your appliance does not only depend on product quality, but on correct installation by a qualified professional.
- Never remove or damage stickers, warning labels or nameplates attached to the appliance.
- A qualified technician carrying out the installation is obliged to observe applicable national standards and regulations concerning connection to the water distribution system and the electric network. The manufacturer is not responsible for any unprofessional or incorrect installation.
- Check that the specifications written on the appliance's identification plate are the same as those of the electrical power supply.

- This appliance is manufactured and tested in accordance with valid regulations.

Installation

- Obey the installation instruction supplied with the appliance.
- Remove all the Packaging items.
- Do not install or use a damaged appliance.
- Before first time starting up, check the appliance for any damage incurred during transport.
- Never remove or damage stickers, warning labels or nameplates attached to the appliance.

Electrical connection

- Only plug the water dispenser directly in the current if it is correctly grounded and with the certain voltage.
- Choose a place that is near a grounded electrical outlet.
- Make sure the appliance is installed correctly. Loose and incorrect electricity mains cable or plug (if applicable) can make the terminal become too hot.
- Make sure that the electrical information on the rating plate agrees with the power supply. If not, contact our Authorised Service Centre or an electrician.
- The appliance has electrical switches in the rear side which is set to turn ON or OFF the water heating and cooling system.
- Do not use multi-plug adapters and extension cables.
- Make sure not to cause damage to the mains plug (if applicable) or to the mains cable. Contact our Authorised Service Centre or an electrician to change a damaged mains cable.

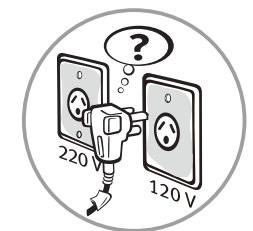
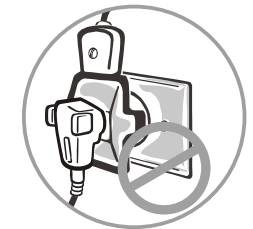

Water connection

- Make sure to use a new water bottle.
- Make sure the water bottle is not faulty - no leakage or holes.
- Make sure to install the bottle as in Catalogue.
- Make sure to use the proper capacity (≤ 20) litre for the water bottle.

Product description

Parts names

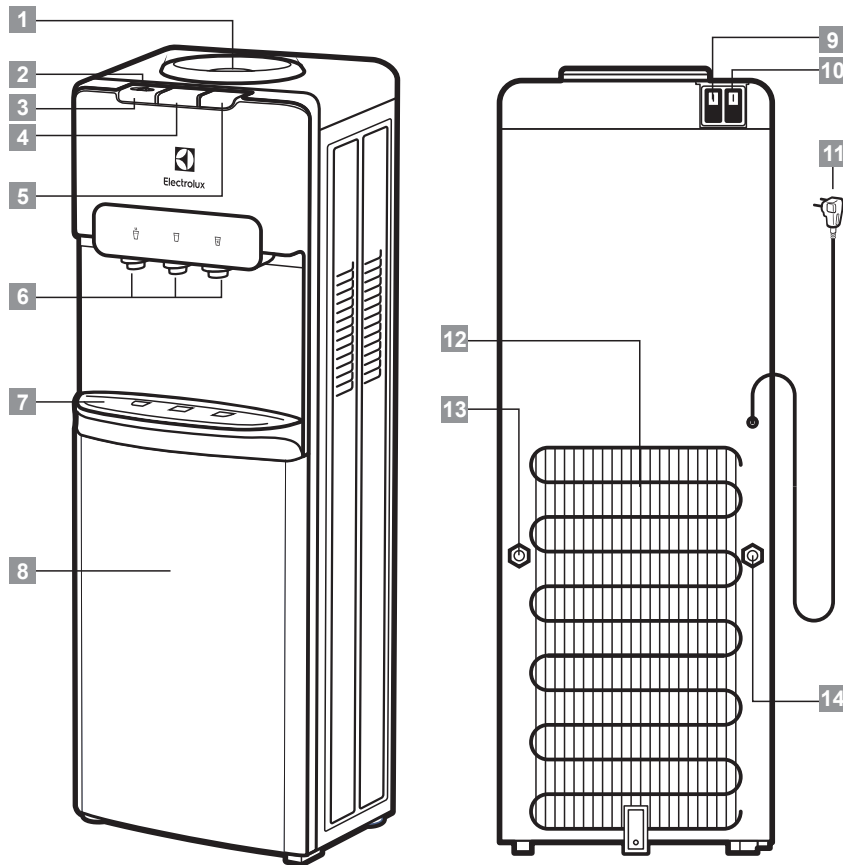

- 1 Hole punch for water bottle
- 2 Child safety switch
- 3 Hot water button
- 4 Ambient water button
- 5 Cold water button
- 6 Spout
- 7 Water collector grid
- 8 Storage space
(For some models)

- 9 Cooling switch
- 10 Heating switch
- 11 Power cord
- 12 Condenser
- 13 Outlet of cold water
- 14 Outlet of hot water

Installation

Placement

Use the appliance indoors, where is no likelihood of rain or bad weather, as there is damage risk to the product electrical system.

The product must be installed in an easily accessible location in case of repairs.

Put the appliance on a flat surface and keep a minimum distance of 25 cm from the wall. Make sure that the ventilation openings of the product are not being obstructed.

To avoid a hazard due to instability of the appliance, it must be fixed in accordance with the instructions:

1. Use 13 mm screw to fix the fixing bracket on the middle of bottom cover.
2. Drill out a screw hole(6 mm) on the floor.
3. Insert a screw anchor (wall plug) into the drilled hole.
4. Move water dispenser, Align fixing bracket hole with screw hole of the floor
5. Put the 25mm screw into the screw hole of fixing bracket.
6. Tighten the screw.

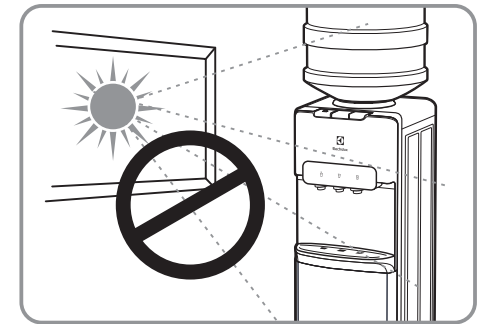

Important

Do not install the water dispenser in a location where there is a direct impact of sunlight or near heat sources, as a stove, oven, etc.

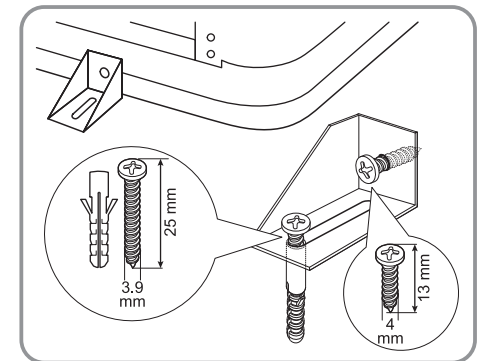

Warning

Do not plug in the device unless the water bottle is already installed and the system is full of water.

Installing the water bottle

Before putting the water bottle:

1. Clean the inside of the water cooler, where the water bottle is placed, with warm water and mild detergent and sterilize as indicated in Care and cleaning section.
2. Clean and sterilize also the water bottle, especially the part that will be inside the water cooler.
3. Leave the protective plastic cap on the bottle, where The product has a hole punch.

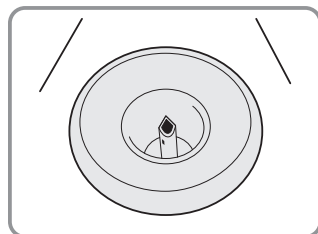

If the user prefers not to use the hole punch, you can pull it off. follow the next instructions:

1. Remove the top cover with the hole punch.
2. Turn clockwise the hole punch to fit it in tears.
3. Remove the hole punch.
4. Replace the lid on the water dispenser.
5. Place the water bottle at the water cooler and make sure that it is well docked.

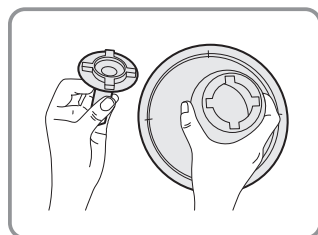
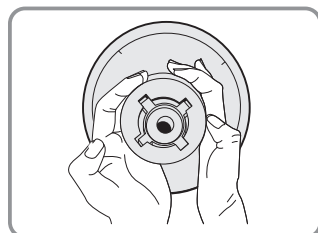
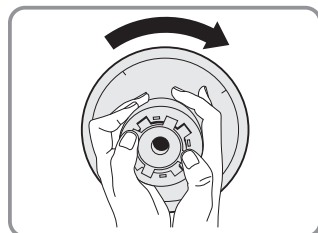

This product was developed to be used with bottles of 10 or 20 litres. Depending on the maker and model of the water bottle, there may be some variation in size. Check, during installation of the bottle, that it is well supported and stable, and there is no risk of falling.

Attention

Never turn the appliance upside down or tilt it more than 45°.

Electrical installation

A short power-supply cord is provided to reduce the risks resulting from becoming entangled in or tripping over a longer cord.

Connect the plug firmly, if the product is connected to an adaptor plug or extension cord, be sure it is not in an area where it will be exposed to water.

After placing the water dispenser, check if it is not over the power cord.

Important

We do not recommend the use of an extension cord or adaptor plug.

Do not fasten, twist or tie the power cord.

Do not try to fix it. If it is damaged, request the visit of a professional technician. If the power cord is damaged, it should be replaced by the service centre technician.

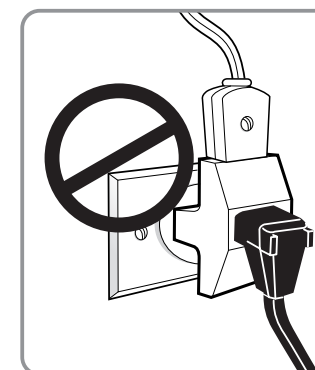
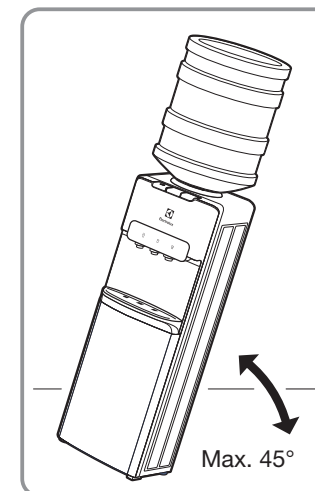
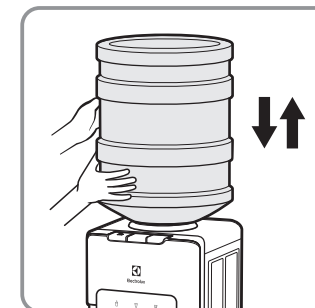

How to use

Activate heating and cooling

This unit will not dispense hot or cold water until the switchers are activated. To activate, push top side of power switches in to start heating and cooling water:

- If you do not want to heat water, push bottom side of red switch in.
- If you do not want to cool water, push bottom side of green switch in.

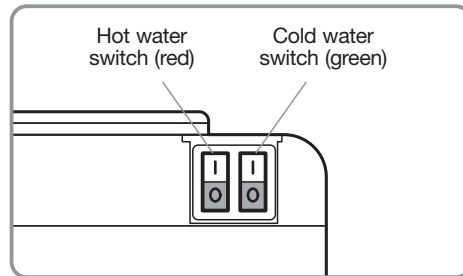

Dispensing water

This unit has been tested and sanitized prior to packing and shipping. During transit dust and odors can accumulate in the tank and lines. Dispense and dispose at least one quart of water prior to drinking any water.

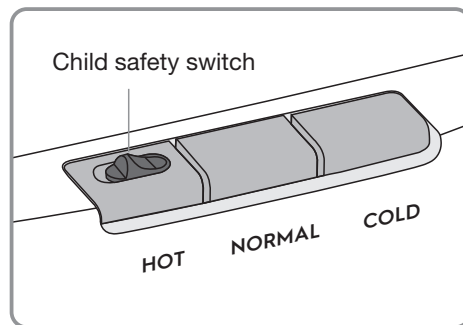

Hot water

To get the hot water: slide the child safety switch to right, and press hot water button simultaneously.

Normal water

To get the room temperature water: put the cup on the water collector grid and press the natural water button.

Cold water

To obtain chilled water put the cup on the water collector grid and press the cold water button.

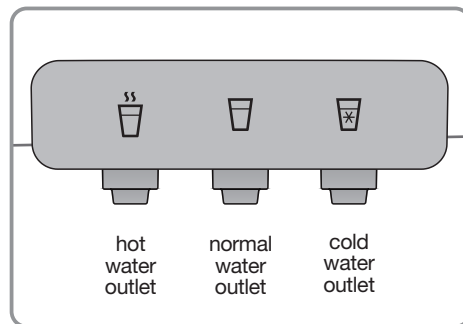

Attention

Never press more than one button at the same time.

Storage with or without fridge (available in some models only)

The water dispenser has a refrigerator to store food and fruits in some models.

To turn on the cooling system it is necessary to activate the cooling switch (green).

In non-refrigerated models there is a hermetic storage cabinet. Do not store any food at this non-refrigerated storage.

When first time to utilize the refrigerating function, let the refrigerating function operated for at least 2 hours before putting anything into the cabinet.

No wet or hot goods is allowed to be put into the cooling cabinet. Leave suitable space between the goods to ensure the interior airflow.

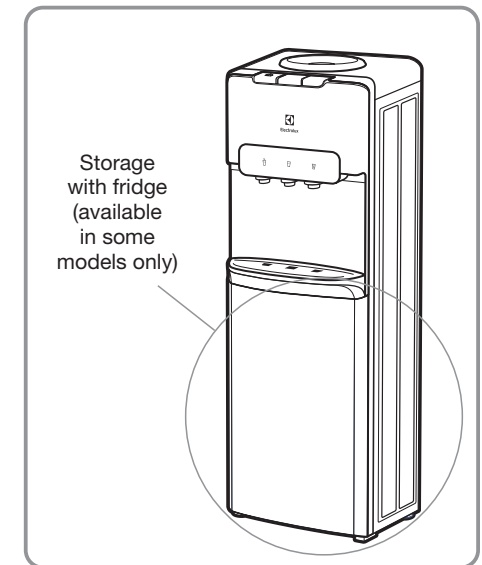

Attention

- When the machine is under the ice point and blocked by ice, the cooling switch must be closed for 4 hours before turning it on again to continue its operation.
- This machine should not be turned on until 3 minutes later after turning off the power switch.
- Do not operate or stop the appliance plugged in by the power cord or by pulling on the power cord. Unplug the power cord by holding it by the plug.
- In case cold or hot water is not needed for a long time, turn off the respective power switch.
- Food and fruits should not be placed on non-refrigerated models to prevent putrefaction.

Care and cleaning

This unit has been tested and sanitized prior to packing and shipping. During transit dust and odors can accumulate in the tank and lines. Dispense and dispose at least one quart of water prior to drinking any water.

Wipe with a soft, clean piece of cloth in part outside of water dispenser regularly.

The water inside the bottle must not contain chlorine additive. So it's very important that the inside of the water dispenser is sterilized and clean.

Do not touch the water outlet to avoid its contamination. The water reservoir must be cleaned and sterilized every 3 months.

Water will fall from the water collector if it is completely filled with water, please empty the water collector periodically.

Never clean your water cooler with flammable fluids such as alcohol, kerosene, gasoline, paint thinner, solvents, chemicals or abrasives as detergents, acids, vinegar or products that might leave the smell.

Wipe the outside of the water dispenser with water and neutral detergent.

Do not use chemical cleaners or volatile solvents, because the product can lose brightness and colour.



Procedure for cleaning & sterilization of the appliance

1. Disconnect the appliance from power source.
2. Remove the water bottle and empty water reservoir through pressing the buttons until there is no water coming out.
3. Open the drainage cap, existing at the back of the dispenser, and ensure that all the water flow out of the appliance.
4. Prepare a chlorinated solution (2 litres of clean water and 0.5 tea spoon of bleach).
5. Place the chlorinated solution in an empty bottle of water and fill your water dispenser.
6. Wait 10 minutes for the chlorinated solution take effect and remove all the water through the drain.
7. Fill 1/3 of the bottle with clean water. Replace the bottle and remove all the water by triggers and drainage cap. This will rinse the tanks and the triggers of your product.

Warning

Always disconnect the water dispenser from power source before cleaning it or doing any maintenance.

Troubleshooting

Certain problems are due to lack of simple maintenance or oversights, which can be solved easily without calling the service technicians, before contacting the service center please carry out the check listed below.

Problem	Possible cause(s)	Solution
Does not work	<ul style="list-style-type: none"> a) Electric plug out of the socket. b) Bonded in different voltage. c) Lack of electric power or fuse blown. d) Make sure cold water switch in the rear side of dispenser is ON. e) Voltage drop. 	<ul style="list-style-type: none"> a) Plug in. b) Connect in correct voltage. c) Wait for electric power ON or change fuse. d) Push the switches to the ON position. e) Use a voltage stabilizer.
Water not cold from cold tank	<ul style="list-style-type: none"> a) Electric plug out of the socket. b) After setup, it will take up to 1 hour to chill the water until minimal set temperature. c) Make sure cold water switch in the rear side of dispenser is ON. 	<ul style="list-style-type: none"> a) Plug in. b) Wait one hour for the cold water supply. c) Push the cold water switch (green) to the ON position.
Water not hot from hot tank	<ul style="list-style-type: none"> a) Electric plug out of the socket. b) After setup, it will take up to 15-20 min to heat the water until maximal set temperature. c) Make sure hot water switch in the rear side of dispenser is ON. 	<ul style="list-style-type: none"> a) Plug in. b) Wait 15-20 min. for the heat water supply. c) Push the hot water switch (red) to the ON position.
Excessive heating around dispenser body	<ul style="list-style-type: none"> a) The appliance very close to a wall. b) Ventilation vents obstructed. 	<ul style="list-style-type: none"> a) The appliance must be at least 25 cm from the wall. b) Clear the ventilation vents.
Noise	<ul style="list-style-type: none"> a) Product leaning on the wall. b) Uneven placement. 	<ul style="list-style-type: none"> a) The appliance must be at least 25 cm from the wall. b) Even the appliance.
Water leakage	<ul style="list-style-type: none"> a) A hole or a crack in the bottle. b) Overflow in the water collector. c) Drainage cap not well tightened. 	<ul style="list-style-type: none"> a) Replace the water bottle. b) Empty the water collector. c) Tighten the cap.

Problem	Possible cause(s)	Solution
Steam coming out of dispenser	<ul style="list-style-type: none"> a) Excessive heating inside the hot water tank. 	<ul style="list-style-type: none"> a) Disconnect the main power source and call service centre.
Unpleasant taste of water	<ul style="list-style-type: none"> a) Cleaning is made with non recommended material. b) Poor-quality water. c) Water bottle shoddy. 	<ul style="list-style-type: none"> a) Follow cleaning/sterilization procedure correctly. b) Make sure that the mineral water supplier is of good quality. c) Replace the water bottle.

