

Electrolux

WE'RE THINKING OF YOU

Thank you for purchasing an Electrolux appliance. You've chosen a product that brings with it decades of professional experience and innovation. Ingenious and stylish, it has been designed with you in mind. So, whenever you use it, you can be safe in the knowledge that you'll get great results every time. Welcome to Electrolux.

BEFORE USING YOUR APPLIANCE

Check for any damage or marks. If you find the appliance damaged or marked, you must report it within 7 days to claim for damages under the manufacturer's warranty. This does not affect your statutory rights.

Before you use the appliance, we recommend that you read through the whole user manual which provides the description of the product and its functions. It is important that the product is installed correctly and that you read the safety instructions carefully to avoid misuse and hazards.

For future reference, please store this booklet in a safe place.

CONDITIONS OF USE

This appliance is intended to be used in household and similar applications such as:

- Staff kitchen areas in shops, offices, and other working environments.
- Farmhouses.
- By clients in hotels, motels, and other residential type environments.
- Bed and breakfast type environments.

BEFORE YOU CALL

Please ensure you read the instruction manual fully before you call for service, or a full-service fee could be applicable.

RECORD MODEL AND SERIAL NUMBER HERE:

Model: _____

Serial No: _____

IMPORTANT INFORMATION THAT MAY IMPACT YOUR MANUFACTURER'S WARRANTY

Adherence to the directions for use in this manual is extremely important for health and safety. Failure to strictly adhere to the requirements in this manual may result in personal injury, property damage and affect your ability to make a claim under the Electrolux manufacturer's warranty provided with your product. Products must be used, installed and operated in accordance with this manual. You may not be able to claim on the Electrolux manufacturer's warranty in the event that your product fault is due to failure to adhere this manual.

CONTENTS

1. General warnings	3
2. Safety instructions	4
3. Product description	6
4. Accessories	6
5. How to use	7
6. Using the accessories	8
7. Cooking guides	9
8. Cleaning and maintenance	10
9. Specification	10
10. Customer care center	11

SYMBOLS

 **WARNING!**

This symbol indicates information concerning your personal safety.

 **CAUTION!**

This symbol indicates information on how to avoid damaging the appliance.

 **IMPORTANT!**

This symbol indicates tips and information about use of the appliance.

1. GENERAL WARNINGS

Important safety instructions, read carefully and keep for future reference. Pass the user manual on to possible new owners of the appliance.

NOTE! You must read these warnings carefully before installing or using the appliance. If you need assistance, contact your Customer Care Department. The manufacturer will not accept liability, should these instructions or any other safety instructions incorporated in this book be ignored.

Children and vulnerable people safety.

WARNING!

Risk of suffocation, injury or permanent disability.

- This appliance is not intended for use by persons (including children) with reduced physical, sensory, or mental capabilities, or lack of experience and knowledge, unless they have been given supervision or instruction concerning use of the appliance by a person responsible for their safety.
- Children should be supervised to ensure that they do not play with the appliance.
- Keep all packaging away from children.
- **WARNING:** Accessible parts may become hot during use. Young children should be kept away.

CAUTION!

Important safety instructions, read carefully and keep for future reference.

General safety

- The interior of the appliance becomes hot when in operation. Do not touch the heating elements that are in the appliance.
- Always use oven gloves to remove or put in accessories or ovenware.
- Before maintenance, disconnect the power supply.
- If the door or door seals are damaged, the appliance must not be operated until it has been repaired by a competent person.
- The appliance is not intended to be operated by means of an external timer or separate remote-control system.
- Do not heat liquids and other foods in sealed containers of any material. They are liable to explode.
- Only use utensils and recommended accessories that are suitable to use in electric ovens.

- The use of accessories not recommended by the appliance manufacturer may cause hazard or injury.
- If smoke is emitted, switch off or unplug the appliance and keep the door closed to stifle any flames.
- The appliance should be cleaned regularly, and any food deposits removed.
- Failure to maintain the appliance in a clean condition could lead to deterioration of the surface that could adversely affect the life span the appliance and possibly result in a hazardous situation.
- The temperature of accessible surfaces may be high when the appliance is operating.
- Do not use harsh abrasive cleaners or sharp metal scrapers to clean the glass door since they can scratch the surface, which may result in shattering of the glass. Contact the Service Centre if require.
- If the supply cord is damaged, it must be replaced by the manufacturer or an authorized service agent or similarly qualified persons to avoid a hazard.

CAUTION!

In order to avoid a hazard due to inadvertent resetting of the thermal cut-out, this appliance must not be supplied through an external switching device, such as a timer, or connected to a circuit that is regularly switched on and off by the utility.

WARNING!

Ensure that the appliance is switched off before replacing the lamp to avoid the possibility of electric shock.

2. SAFETY INSTRUCTIONS

2.1 Installation

! CAUTION!

- If the oven is positioned too close to the wall, the wall will be burned or stained. Be sure the curtain is not in contact with the oven body.
- Do not put anything between the bottom of the body and the counter surface on which it is set; such object could be burnt.
- When operating the oven, keep at least 10cm of space on all sides of the oven to allow adequate air circulation. It's recommended to have at least 30cm space between the top of oven and bottom of cabinet.

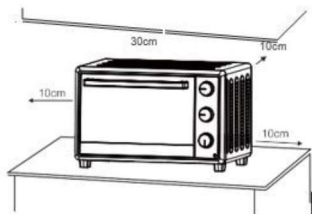

- The rear surface of appliances should be placed against the wall with gap for ventilation.
- Do not cover any parts of the oven with metal foil. This may cause overheating of the oven.
- Do not put anything on the oven while using it. The heat could cause deformation, crack, etc.
- Do not store any flammable material on the oven during operation, it can cause fire.
- Do not rest cooking utensils or baking dishes on the glass door, it could cause unit to fall.



- The temperature of the door or the outer surface may be higher when the appliance is operating. Temperature of accessible surfaces may be high when the appliance is operating
- The metal parts and glass window of the door become extremely hot during use; be careful not to touch them when opening and closing the door.

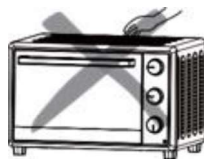

2.2 Electrical connection

! CAUTION!
Risk of fire and electrical shock.

- AC power must be taken from a properly wired outlet. Insert the plug completely into the socket. If it is not properly connected, it will become abnormally hot.
- Do not use an electric light outlet. Never connect multiple plugs to the same outlet.
- When unplugging the cord, always take hold of the plug itself. Never pull on the cord; doing so could break the wires inside the cord.



- When using the oven, do not place the unit close to the gas burner or other source of high temperature or block the electric fan at the oven as it could prevent the oven to get the correct temperature control.
- Do not handle the power cord or the appliance with wet hands. Always unplug the cord after use. Any malfunctioned unit with plug inserted into the outlet could cause fire hazard



- When cooking oil-splashing dishes such as roast chicken, it is recommended to put 2 sheets of aluminum foils on a tray to diminish oil splashing.



2.3 Use



WARNING!

Risk of injury, burns or electric shock or explosion.

- Do not use it outdoors.
- Do not use the appliance for other than intended use.
- Use this appliance in a household environment.
- Do not change the specification of this appliance.
- Make sure that the ventilation openings are not blocked.
- Do not leave the appliance unattended during operation.
- Do not apply pressure on the open door.
- Do not use the appliance as a work surface and do not use the cavity for storage purposes.
- Do not operate appliance without food.
- Non-high temperature resistant metallic containers for food and beverages are not allowed during cooking.
- Do not place any of the following materials in the appliances: cardboard, plastic, paper, or anything similar.

2.4 Care and cleaning



WARNING!

Risk of injury, fire or damage to the appliance.

- Before maintenance, switch off the appliance and disconnect the main plug from the main socket.
- Regularly clean the appliance to prevent the deterioration of the surface material.
- Do not allow food spills or cleaner residue to accumulate on door sealing surfaces.
- Residual fat or food in the appliance can cause smoke/fire, particularly on the heating element.
- Clean the appliance with a moist soft cloth. Only use neutral detergents. Do not use abrasive products, abrasive cleaning pads, solvents, or metal objects.

2.5 Disposal



WARNING!

Risk of injury or suffocation.

- Disconnect the appliance from the main supply.
- Cut off the main cable and discard it.

3. PRODUCT DESCRIPTION

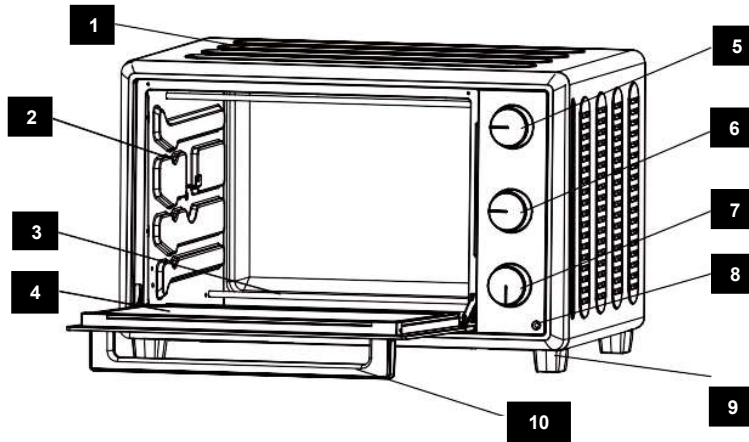

- | | |
|---------------------------|-------------------|
| 1 Housing | 6 Function knob |
| 2 Inner cavity | 7 Timer knob |
| 3 Heating element | 8 Indicator light |
| 4 Double-layer glass door | 9 Support foot |
| 5 Temperature knob | 10 Door handle |

4. ACCESSORIES

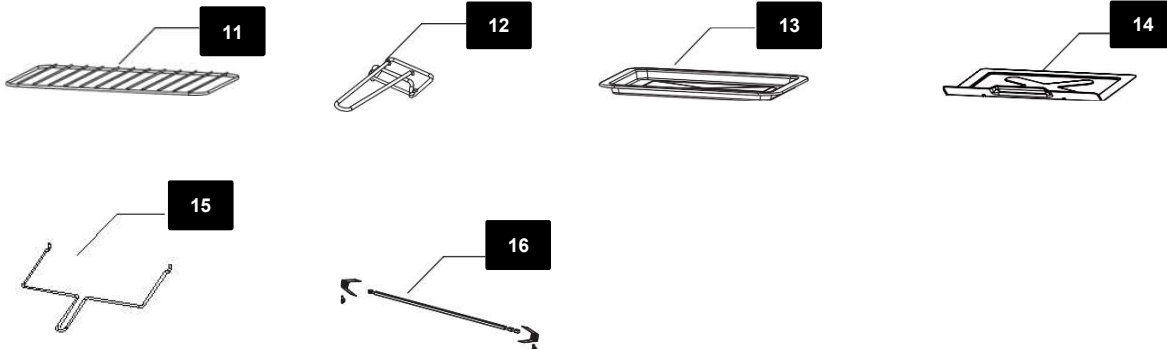

- | |
|----------------------------|
| 11 Grill rack |
| 12 Tray picker |
| 13 Enamel-coated bake tray |
| 14 Crumb tray |
| 15 Rotisserie handle |
| 16 Rotisserie fork |

5. HOW TO USE

5.1 Before using the unit for the FIRST TIME

- Heat the empty oven
- Clean the accessories
- Insert the tray and grill rack
- Select the function knob , set the temperature at 230°C and heat the empty oven for about 10 minutes.

Note: There may be some smoke and a burning smell at first. This is not a malfunction.

5.2 Select a TEMPERATURE

- Select the proper temperature according to the food or personal preference by turning the knob clockwise.

Note: There may be some discrepancy between the set temperature and the actual temperature.

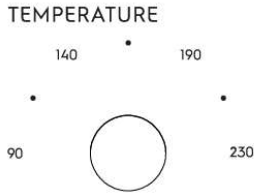





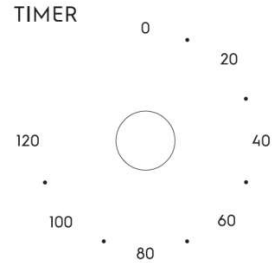

5.4 Select time

- Set the arrow on the timer knob to the number which indicates the cooking time (minutes) according to the food you want to cook or personal preference.
- Set the timer by turning it clockwise. The oven will turn off automatically at the end of the selected time and the bell will ring. If the required time is less than 10 minutes, turn the knob over 40 minutes and then back to the require time.
- The oven can be turned off manually during cooking by turning the timer anti-clockwise to the "0" position.

Note: If the inside of the oven is dirty, cooking may take slightly longer than usual. The oven light will switch on only when you set the time.





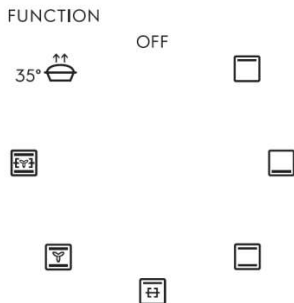

5.3 Select a FUNCTION

- OFF
-  Upper Heating
-  Lower Heating
-  Upper & Lower Heating
-  Upper heating + Rotisseries Function
-  Upper & Lower Heating + Convection
-  Upper & Lower Heating + Rotisseries + Convection Function
-  35° Fermentation
- Select "FUNCTION " by turning the knob clockwise for suitable heating function.
- You can observe whether the heaters are working or not by observing the front indicator light. (missing full stop)

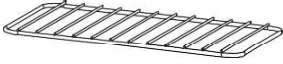

6. USING THE ACCESSORIES

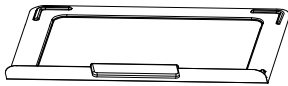
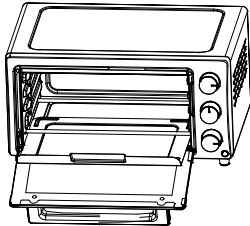
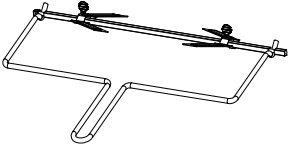
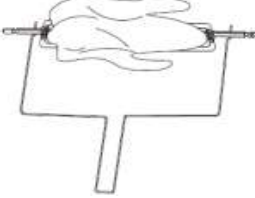
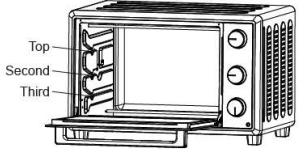
Accessories	Description	How to use
 <p data-bbox="245 415 513 443">Enamel-coated bake tray</p>	<p data-bbox="573 268 980 352">Use the tray to roast chicken, hamburger, steak, gratin, sponge cake, or almost all other oven-cooked food.</p>	 <p data-bbox="1024 432 1349 516">When the tray or rack is hot, please use tray picker to take the tray out from the oven.</p>
 <p data-bbox="334 726 431 753">Grill rack</p>	<p data-bbox="573 604 971 657">Use grill rack to bake potato, dry food etc.</p>	
 <p data-bbox="245 989 513 1062">Enamel-coated bake tray and grill rack</p>	<p data-bbox="573 856 980 940">Use bake tray and grill rack together for food which has water or oil dripping.</p>	
 <p data-bbox="318 1289 448 1316">Crumb Tray</p>	<p data-bbox="573 1213 980 1266">Use the crumb tray to hold bread crumbs, dirties during cooking.</p>	
	<p data-bbox="573 1486 980 1539">Use Rotisserie handle to take out the rotisserie rod.</p>	
 <p data-bbox="293 1885 431 1913">Tray support</p>	<p data-bbox="573 1738 980 1812">You can put the tray or grill rack at the middle shelf position according to the food you want to cook.</p>	<p data-bbox="1008 1738 1416 1875">When making macaroni gratin and you want to have the top part cooked the most, use the top or the second rack support. For roasting a chicken, use the third rack support.</p>

7. COOKING RECIPES

EOT3218XG

Menu	Weights/ Amount	Temperature setting (°C)	Time (min.)	Food tray position	Function selection
Hamburger	4-6 pcs	200°C	4-5	Middle	Bottom + Top Heating
Sausage	12-14 pcs	200°C	14-16	Middle	Bottom + Top Heating
Ham	6 pcs (1mm thickness)	200°C	13-15	Middle	Bottom + Top Heating
Fish	300-600g	230°C	38-40	Middle	Bottom + Top Heating
Toast	6 pcs (10cm*10cm*1cm)	230°C	4-5	Middle	Bottom + Top Heating
Pancake	6-8 pcs	180°C	11-13	Middle	Bottom + Top Heating
Chicken	Whole chicken (1.5-2KG/pc)	200°C	60-65	Rotisserie position	Bottom + Top Heating + Rotisseries + Convection
Steak	4-6 pcs (1-2cm thickness)	230°C	12-15	Middle	Bottom + Top Heating
Pizza	12 inches	200°C	13-15	Middle	Bottom + Top Heating
Sandwich	4-6 pcs	170°C	10-12	Middle	Bottom + Top Heating
Cake	1pc (8 inches)	150°C	38-40	Middle	Bottom + Top Heating

*Note: Cooking time need to be adjusted if volume/ quantity is more than recommend recipes.

8. CLEANING AND MAINTENAINCE



WARNING!

Notes on cleaning:

- After use, set all switches to "0"/"OFF" position. Always unplug the unit and wait until the interior parts of the oven have completely been cooled down before cleaning.
- Use a damp cloth to clean the inside and outside parts of the oven. Do not use abrasive or corrosive cleaners.
- Do not immerse the unit, power cord, and plug into water or other liquids.
- Wash all accessories in warm soapy water.
- Allow all the parts to dry thoroughly before plugging the oven toaster into the wall socket.
- When food have accumulated at the bottom of the unit, it can impair the performance. Remove the crumb tray provided for easy cleaning.

Notes on storage:

- Follow the above cleaning instruction for well maintenance before storage.
- Tidy up the power cord.
- The unit and its accessories should be stored at dry and cool place.

Notes:

- Do soak the food tray with warm water as it will make cleaning easier.
- To remove any cooking spatters, wipe the interior of the oven toaster with some mild detergent on a damp sponge, cloth, or nylon-scouring pad.
- Sugar and salt-based food tend to stick to all surfaces and are very hard to clean. When cooking these types of food, clean the food tray and grill rack immediately after each use.

9. SPECIFICATION

Specs/ Models	EOT3218XG
Power supply	220-240V ~50-60Hz
Power consumption	1800W
Capacity	32.0L
Temperature Settings	90°C - 230°C
Timer	120mins
Net weight (approx.)	9.6kg
Power cord length	0.8m
Unit Dimension (W x D x H) mm	523X352X337mm
Carton Dimension (W x D x H) mm	595X426X407mm

Customer care center

<p>Thailand Consumer Care Tel : (+66 2) 725 9000 Electrolux Thailand Co., Ltd. Electrolux Building 14th Floor 1910 New Phetchaburi Road, Bangkok, Huai Khwang, Bangkok 10310 Office Tel : (+66 2) 7259100 Office Fax : (+66 2) 7259299 Email : customercarethai@electrolux.com</p>	<p>Malaysia Consumer Care Center Tel: 1300-88-11-22 Electrolux Home Appliances Sdn. Bhd. Corporate Office Address: Unit T2-7, 7th Floor, Tower 2, PJ33, No. 3, Jalan Semangat, Seksyen 13, 46200 Petaling Jaya, Selangor. Office Tel : (+60 3) 78435999 Office Fax : (+60 3) 7955 5511 Consumer Care Center Address: Lot C6, No. 28, Jalan 15/22, Taman Perindustrian Tiong Nam, 40200 Shah Alam, Selangor Consumer Care Center Fax : (+60 3) 5524 2521 Email : malaysia.customercare@electrolux.com</p>
<p>Indonesia Hotline service: 08041119999 PT. Electrolux Indonesia Electrolux Building Jl.Abdul Muis No.34, Petojo Selatan, Gambir Jakarta Pusat 10160 Email:customercare@electrolux.co.id SMS & WA : 0812.8088.8863</p>	<p>Philippines Consumer Care Center Toll Free : 1-800-10-845-CARE(2273) Consumer Care Hotline : (+63 2) 845-CARE(2273) Electrolux Philippines, Inc. Unit B 12F Cyber Sigma Bldg, Lawton Avenue, McKinley West, Taguig, Philippines 1634 Trunkline: +63 2 737- 4757 Website : www.electrolux.com.ph Email : wecare@electrolux.com</p>
<p>Vietnam Consumer Care Center Toll Free: 1800-58-88-99 Tel: (+84 28) 3910 5465 Electrolux Vietnam Ltd. Floor 9th, A&B Tower 76 Le Lai Street - Ben Thanh Ward - District 1 Ho Chi Minh City · Vietnam Office Tel: (+84 28) 3910 5465 Office Fax: (+84 28) 3910 5470 Email: vn-care@electrolux.com</p>	<p>Singapore Consumer Care Center Tel: (+65) 6727 3699 Electrolux S.E.A. Pte Ltd. 351 Braddell Road, #01-04 Singapore 579713. Email : customer-care.sin@electrolux.com</p>
<p>Korea Contact Center: 1566-1238 Electrolux Korea Ltd. 9th Floor, Pine Avenue B, 100 Eulji-ro, Jung-gu, Seoul 04551, Korea Electrolux Korea Home page: www.electrolux.co.kr Customer Care Home page: www.electroluxconsumer.co.kr Email: homecare.krh@electrolux.com</p>	<p>Taiwan Consumer Care Center Toll Free: 0800-888-259 Electrolux S.E.A Private Limited Taiwan Branch 9F, No. 68, Sec. 2, Xianmin Blvd, Banqiao Dist., New Taipei City 22065, Taiwan Office Fax: (+886) 2 89645269 Email: service.tw@electrolux.com</p>

RoHS
Compliant

Conformed to the stipulation on permissible content limitation of some hazardous & restricted chemical substances.

(RoHS compliant)

(According to the Circular No. 30/2011/TT-BCT, Vietnam, dated 10th August 2011)

