

Dimension Guide

Freestanding electric oven

Model:
EOT2115X

Dimensions

	width	height	depth
Product (mm)	531	368	379

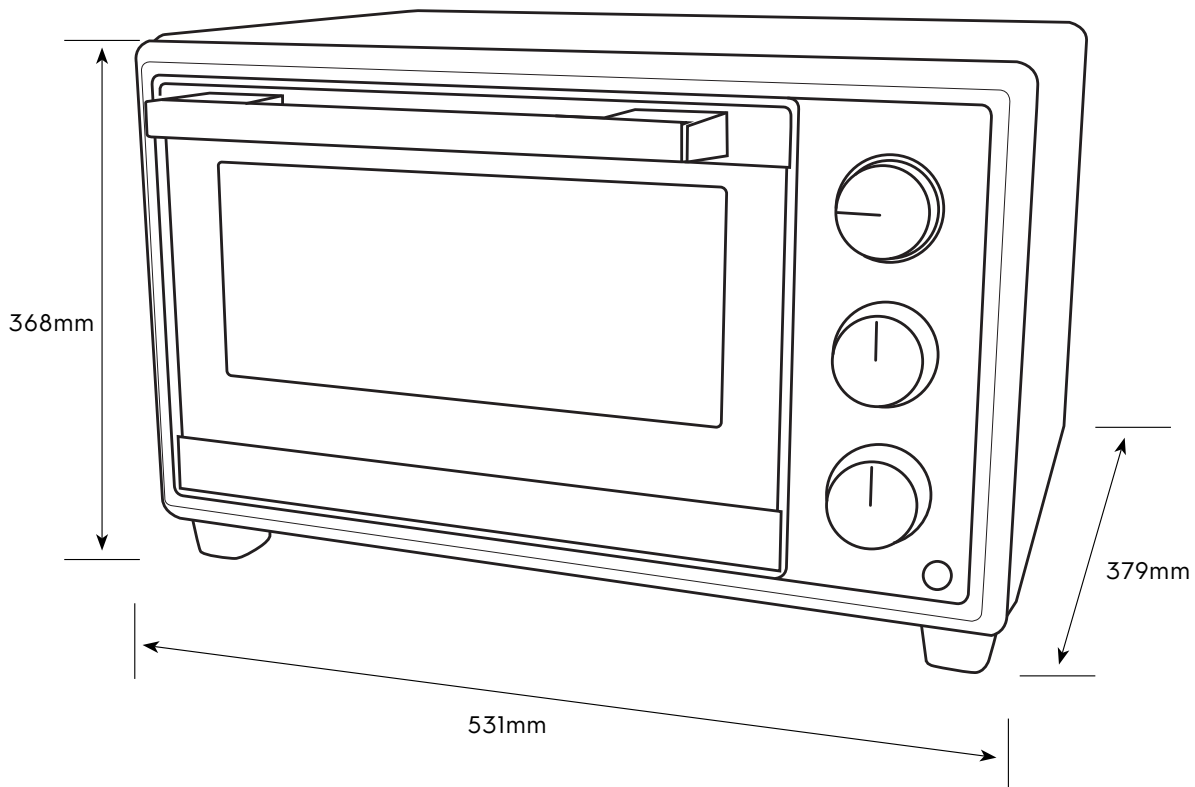

Please note! Dimensions to be used as a guide only. All customers MUST refer to the user manual supplied with the product for detailed installation instructions.
© 2019 Electrolux Home Products Pty Ltd. E_DIM_EOT2115X_Sep21