

EWE381SX1G6
EWE481SX1G6
EWE451SB-G6
EWE361SB-G7
EWE241SX-G6

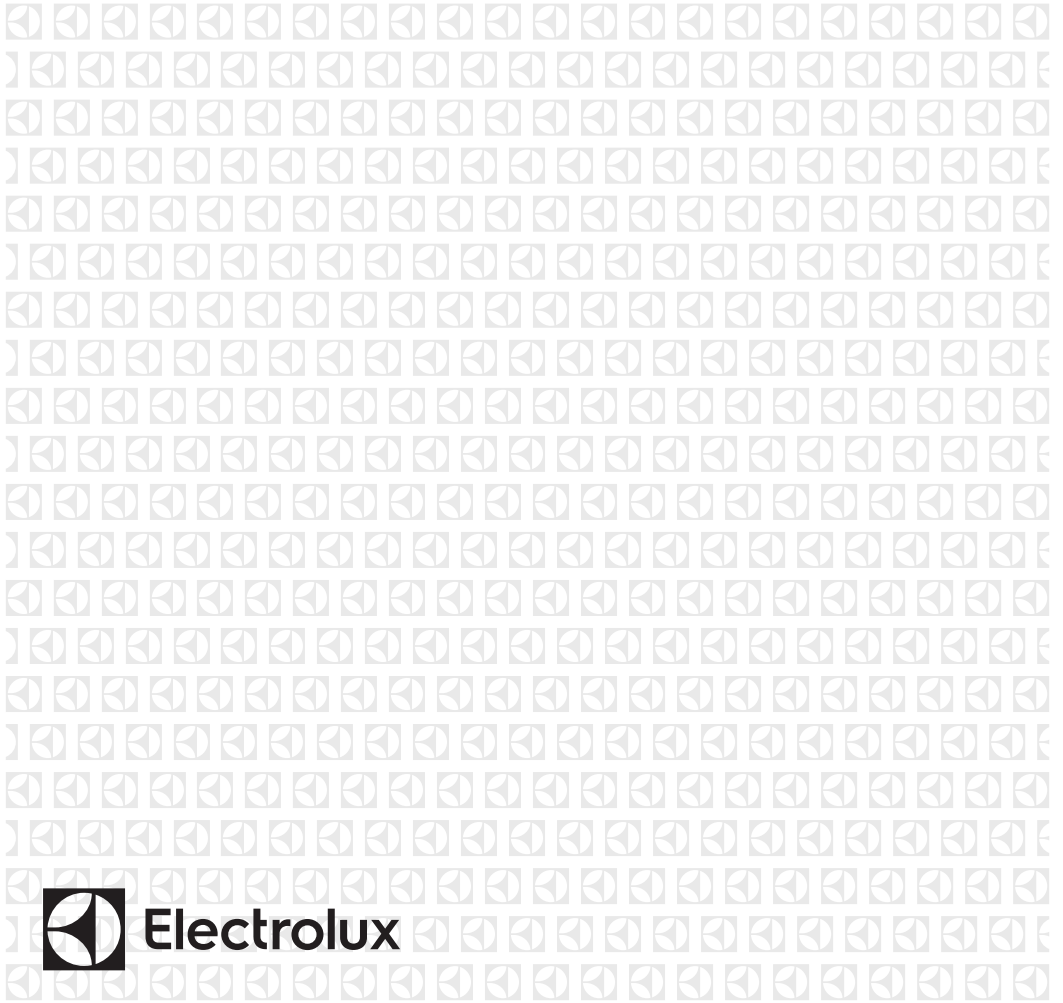

EN UH900 ELECTRIC WATER HEATER

INSTALLATION GUIDE & USER MANUAL



1. PARTS IDENTIFICATION

Main Product

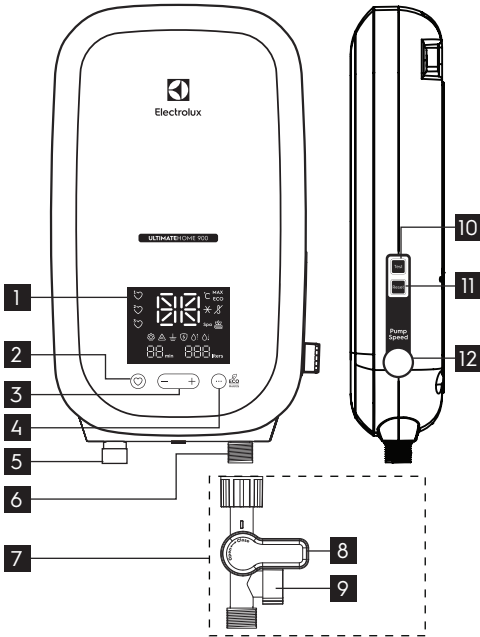

1. Main Display
2. Favorite Button
3. Temperature control buttons
4. Mode button
5. Water outlet
6. Water inlet
7. 3 in 1 Stop Valve
8. Stop Valve Lever
9. Built-in-Filter
10. Test button
11. Reset button
12. Pump knob*

*Pump knob is for models with pump feature only

Product Inside

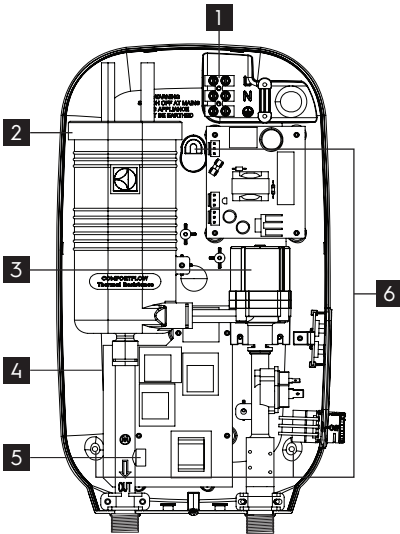

1. Terminal Block
2. Heater Tank
3. D.C. Silent Pump (pump models only)
4. Main Control PCB
5. Thermistor
6. Hanging holes

1. PARTS IDENTIFICATION(Continued)

Shower Accessory

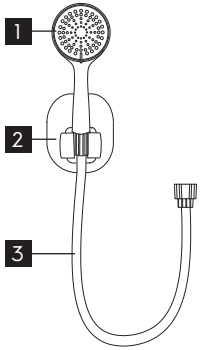

3-way shower
with Bracket Holder

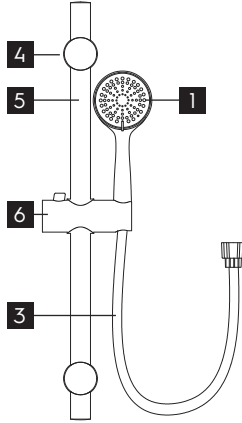

3-way shower
with Slider Bar

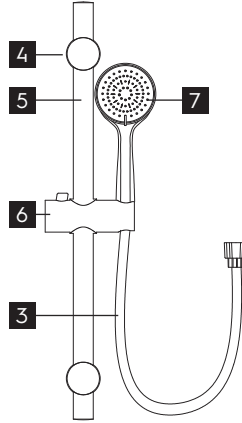

5-way shower
with Slider Bar

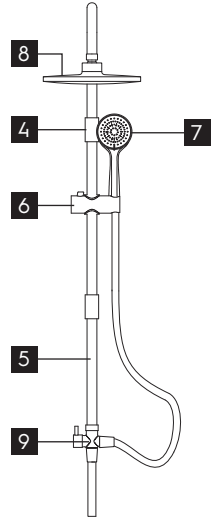

Rain shower
accessory

1. 3-way shower head
2. Shower Bracket Holder
3. PVC Hose
4. Rail Bracket

5. Slider Rail
6. Adjustable Shower Holder
7. 5-way shower head
8. Rain Shower Head
9. Selector Valve

Note: Shower accessories may vary depending on the model of the electric water heater. All drawings are for reference only, and the actual product may be slightly different.

2. SAFETY INFORMATION

Products manufactured by Electrolux are safe provided they are installed, used, and maintained in good working order in accordance with our instructions and recommendations. Always refer to this manual if you have any doubt.

The Electric Water Heater must be earthed. Improper grounding could cause electrical shock.

If any of the following conditions occur, immediately switch off the power supply and contact the Electrolux Consumer Care Center. Never attempt to repair the Electric Water Heater by yourself:

- Odd noise, smell, or smoke from the Electric Water Heater.
- ELCB trips and Electric Water Heater Indicator does not light up.
- Inability to control water temperature.

- Distinct change in performance.
- Water leakage from inside.

If the temperature display does not go off when you turn off the water, switch OFF the mains supply and contact Electrolux Consumer Care Centre for repair service. Special skill is required for repairing.

NEVER try to repair the unit by yourself.

For Pump Models, it is highly recommended to connect the Water Inlet Connection to a tank storage supply; otherwise, it may cause damage to the Pump Motor.

When the Electric Water Heater is used by someone such as a child, elderly person, sick person, or physically handicapped person, the person concerned is kindly requested to pay attention and check the shower temperature by hand from time to time.

2. SAFETY INFORMATION(Continued)

Before using the Electric Water Heater, it is advisable to test and adjust the water temperature according to your preference.

During lightning or thunderstorms, switch off the power supply to the Electric Water Heater in advance to prevent possible damage.

Ensure that the earth continuity conductor of the electrical installation is effectively connected to all exposed metal parts of other appliances and services in the room. This ensures proper earthing/grounding for the ELCB (Earth Leakage Circuit Breaker) to be effective and conforms to local regulations.

WARNING: Metallic / chromed hose and conductive control valve shall not be used.

Note that when removing the Electric Water Heater from its package, a small amount of water may be found inside. This is normal as the Electric Water Heater undergoes testing during the manufacturing process.

CAUTION !

Installation must be carried out by qualified personnel and in compliance with local authority regulations.

This Electric Water Heater must be permanently connected to the direct main line supply. The use of a plug and socket is not recommended.

Refer to Table 1 for the correct size of wire conductor corresponding to different electrical loadings.

This Electric Water Heater operates at a minimum water flow rate of 2.0 liters/min (2.2 f/Min for 4.8kW & 2.5 f/min for 6.0kW model only) and a maximum working pressure of 6 bars. For direct connection from the water tank, the Electric Water Heater must have an installation minimum 1.0m below the water tank.

The built-in ELCB (Earth Leakage Circuit Breaker) will automatically cut off the power supply in case of current leakage over 15mA.

The thermostat will automatically cut off the power supply if it senses an abnormal rise in water temperature.

The spray head must be descaled regularly to ensure optimal performance and safety.

Do not switch on the Electric Water Heater if there is a possibility that the water inside the heater is frozen.

Ensure that the outlet is not connected to any tap or fitting other than those specified.

The water inlet of this appliance should not be connected to inlet water obtained from any other water heating system.

This appliance is not intended for use by persons (including children) with reduced physical, sensory or mental capabilities, or lack of experience and knowledge, unless they have been given supervision or instruction concerning use of the appliance by a person responsible for their safety.

Children should be supervised to ensure that they do not play with the appliance, minimizing the risk of accidents.

Ensure that means for disconnection are incorporated in the fixed wiring in accordance with wiring rules for added safety.

WARNING: This appliance is not to be used for a potable water supply.

Means for disconnection must be incorporated in the fixed wiring in accordance with the wiring rules.

3. INSTALLATION

3.1 Product Mounting

1. Select a suitable position in the bathroom.
 Note: The bottom of the water heater should be slightly higher than the shower head holder during normal usage to avoid water splashing on the water heater.

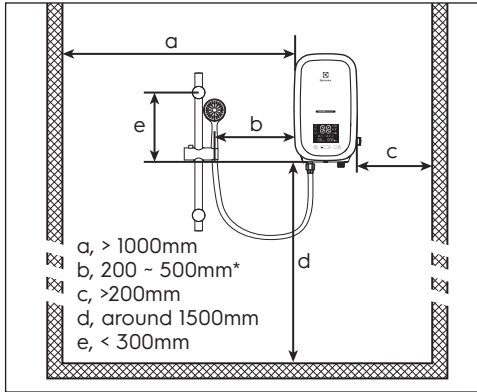

*For rain shower model, recommend distance is 400 - 500mm

2. Remove the screw (A) at the bottom of the Electric Water Heater. Keep screw for reinstalling.

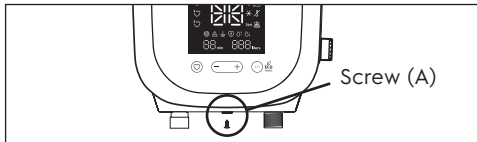

3. Remove the Front Cover from the bottom and then lift up the front cover. Unplug the connecting cable from the Main Control PCB on the back of the front cover.

4. Mark 3 screw points of the Heater Base on the wall. The Electric Water Heater position should be 1.5m above the bathroom floor.

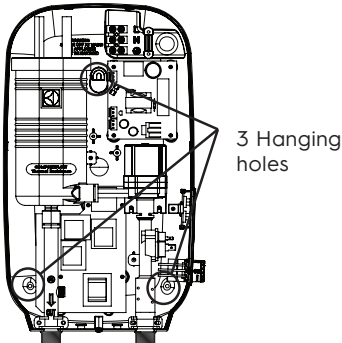

5. Use a 6mm diameter drill bit and make the wall plug holes with a depth of 34mm for mounting the Electric Water Heater.

6. Insert the wall plugs and mount the Electric Water Heater firmly in position with the screws provided.

3.2 Shower Accessory Mounting

Bracket Holder (for Bracket holder models):

Open the Shower Holder cover, mark 2 screw points of the Shower Holder beside the Electric Water Heater. It is recommended that the top of the portion is level with the top Electric Water Heater. Drill 6mm diameter holes with a depth of 34mm, insert the wall plugs, and mount the bracket holder base with the screws provided. Put back the shower holder cover. Install the Shower head with PVC hose provided.

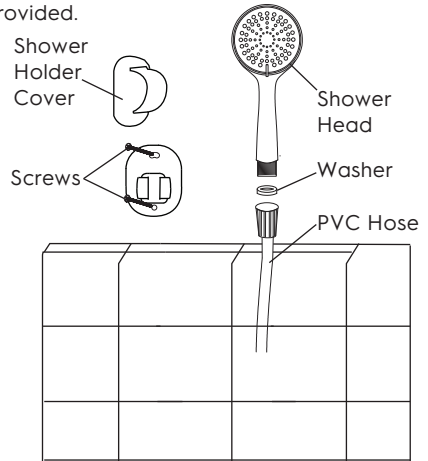

Slider Bar (for slider bar models):

Using a screwdriver, open the cap of the Rail Bracket as shown below.

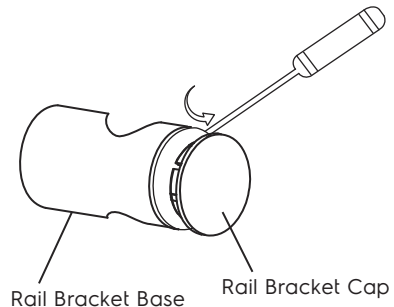

3. INSTALLATION(Continued)

Select a suitable position for the slider rail shower set then mark 2 screws point (1 on top and 1 on bottom). It is recommended that the Top Rail Bracket position at a height of 1800mm to the floor and Bottom Rail Bracket 1400mm to the floor.

Use a 6mm diameter drill bit and make the wall plug holes with a depth of 34mm. Insert the wall plugs and mount the Rail Bracket Base firmly in position with the screws provided.

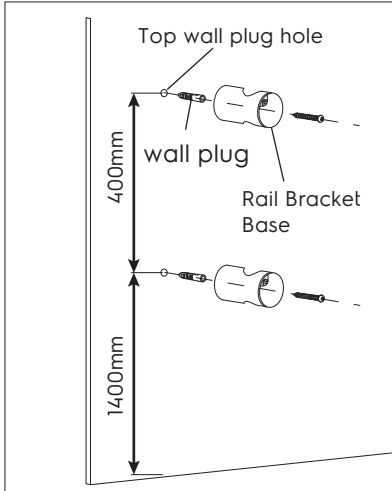

Grab the Slider Rail and pass it through the top Rail bracket, shower head holder, and bottom Rail bracket in sequence.

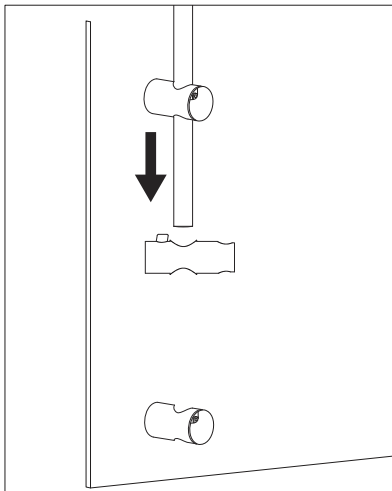

Fix the Slider Rail by tightening screw B on Rail Bracket, then reinstall the caps as shown below.

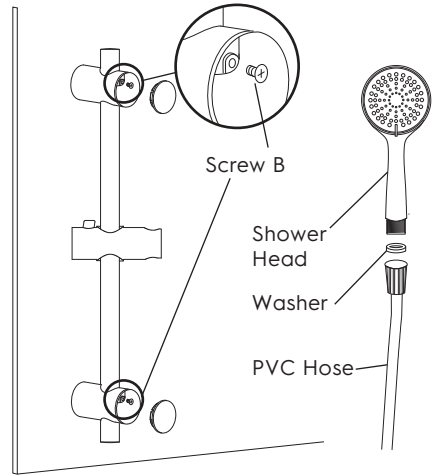

Install the Shower head with PVC hose provided.

Rain shower (for rain shower models):

Open the Rail Bracket cover.

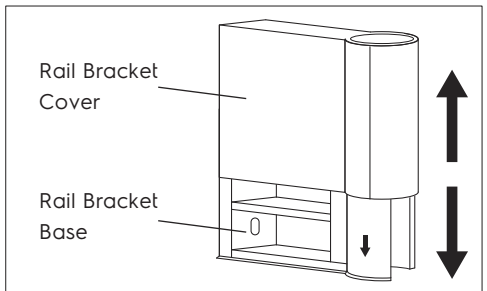

Take out the rubber stopper.

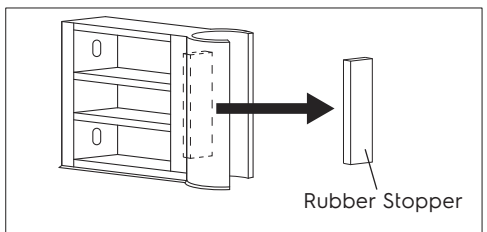

3. INSTALLATION(Continued)

Select a suitable position for the slider rail shower set then mark 4 screw points (2 on top and 2 on bottom). It is recommended that the Top Rail Bracket position at a height of 1950mm to the floor and Bottom Rail Bracket 1300mm to the floor.

Use a 6mm diameter drill bit and make the wall plug holes with a depth of 34mm. Insert the wall plugs and mount the Rail Bracket Base firmly in position with the screws provided.

Note: The arrow on the Rail Bracket Base must face up.

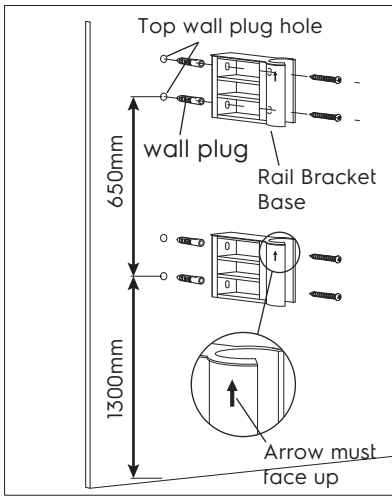

Reinstall the rubber stopper to the 2 Rail Bracket Base.

Grab the Slider Rail and pass it through the top Rail bracket cover, shower head holder, and bottom Rail bracket cover in sequence.

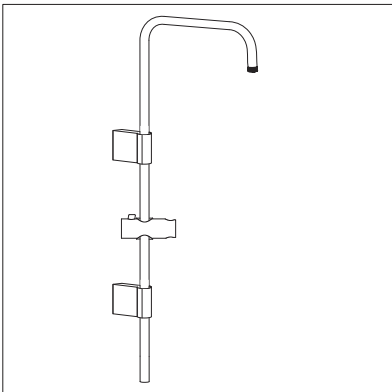

Press the Slider Rail into the Rail Bracket Base and reinstall the Rail Bracket Cover.

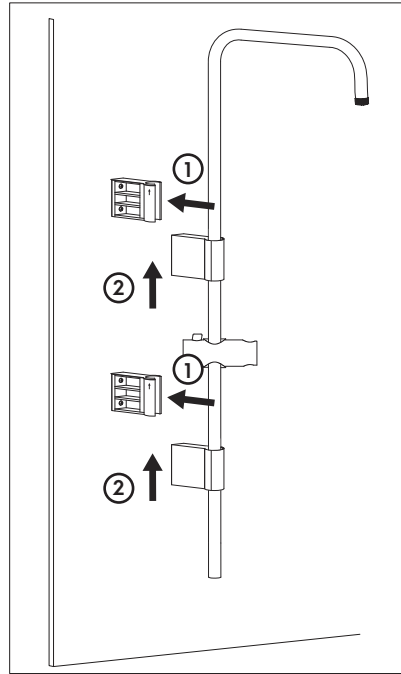

Install the Selector Valve.

Note: Rotate the selector Valve anticlockwise to tighten.

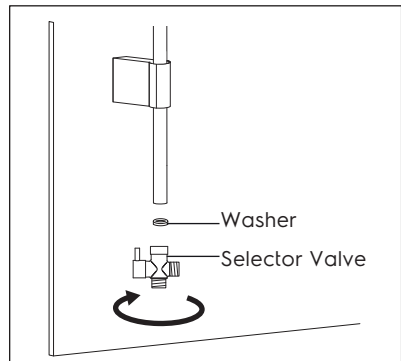

3. INSTALLATION(Continued)

Install rail shower head, hand shower head, and connect PVC hose to the water inlet of the Selector Valve as shown below:

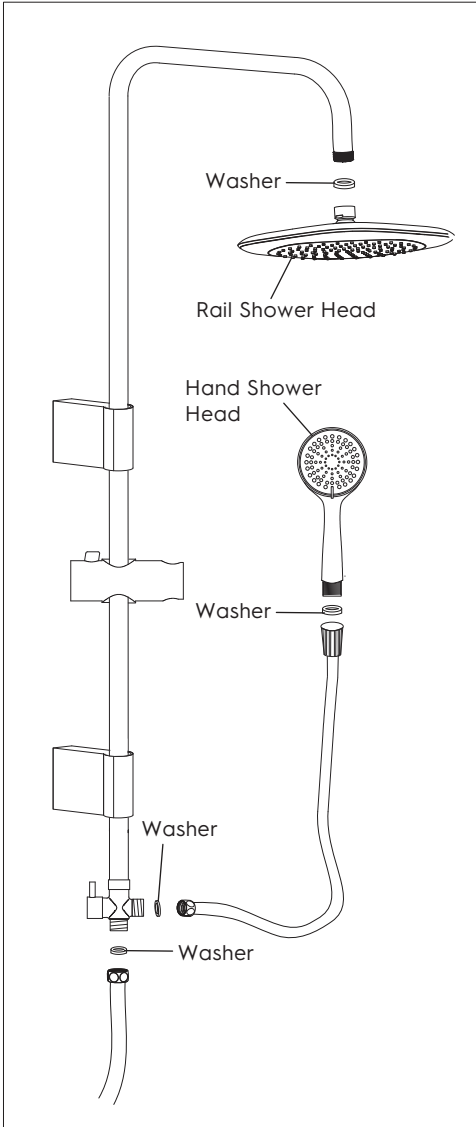

3.3 Plumbing Procedure

CAUTION!

This Electric Water Heater is a single-point system, and the "Water Outlet" can only be fitted to the Hose and Hand shower set provided. MUST NOT CONNECT CONTROL VALVE OR FITTING TO THE WATER OUTLET.

1. Connect the 3 in 1 Stop Valve to the Water Inlet with a washer. Use correct tools to tighten and be careful not to over tighten and damage the plastic nut.

2. Connect the incoming water piping to the 3 in 1 Stop Valve (1/2" BSP).

Note: Make sure to put the Mesh Filter between 3 in 1 Stop Valve and incoming water piping.

3. Turn on the water mains to drain out all plumbing dirt before connecting the water supply to the Electric Water Heater.

Note: The water supply to the Electric Water Heater must be free from mud and dirt.

4. Turn off the water mains and connect the water outlet to the shower head hose.

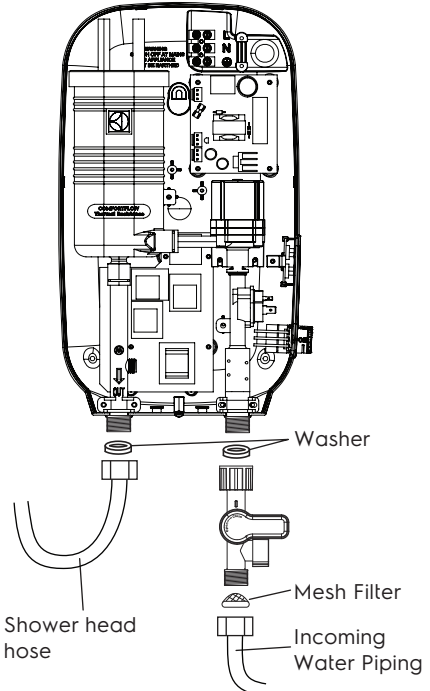

5. Open the water supply again and check for any water leakage.

3. INSTALLATION(Continued)

IMPORTANT!

For Pump Models, it is highly recommended to connect the Water Inlet Connection to a storage supply tank; otherwise, it may cause damage to the Pump Motor.

WARNING!

THE HEATER TANK MUST BE FILLED UP WITH WATER BEFORE TURNING ON THE ELECTRICITY SUPPLY TO PREVENT ANY DRY BURNT DAMAGE TO THE HEATING ELEMENT. THE WATER INLET AND OUTLET MUST BE INSTALLED CORRECTLY, OTHERWISE, THE ELECTRIC WATER HEATER WILL NOT FUNCTION.

DO NOT APPLY PLUMBING CEMENT ON ANY OF THE CONNECTIONS. MAKE SURE TO ONLY USE THREAD OR SEALING TAPE AT 3 in 1 STOP VALVE INLET.

MUST USE 3 in 1 STOP VALVE ACCESSORIES PROVIDED WITH THE ELECTRIC WATER HEATER.

3.4 Electrical Installation

WARNING!

EARTHING:

A) The Earthing installation should be carried out in accordance with the local Wiring Regulations.

B) The Electric Water Heater must be earthed. Improper grounding, such as Earth conductor not grounded (floating) or having high resistance to ground, could cause malfunction to ELCB (Earth Leakage Circuit Breaker) and electrical shock. Never use water heater if there is doubt on Earthing installation.

Always SWITCH OFF the mains electric power supply before carrying out any electrical work.

Use double insulation cable and choose correct cable size as TABLE 1 for electrical installation.

Refer to SAFETY INFORMATION before Plumbing and Electrical Installation for safety and warning details.

1. Lead the power cable from MCB to an "ON/OFF" double-pole switch having a contact separation of at least 3mm in all poles outside the bathroom, then lead a cable to the terminal block inside the Electric Water Heater Unit.

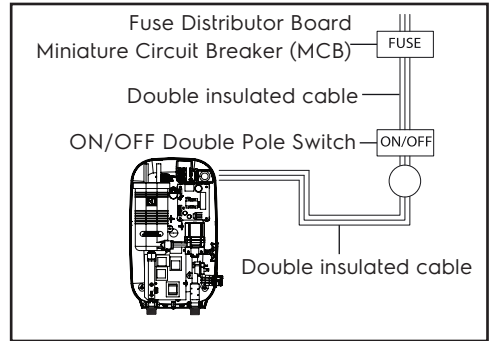

NOTE: Refer to TABLE 1 for electrical loading and correct size of wire conductor

2. Insert the wall embedded cable through Side Entry 'A' by cutting a hole at the source cord rubber holder and lead the cable to Cable Bracket 'B'.

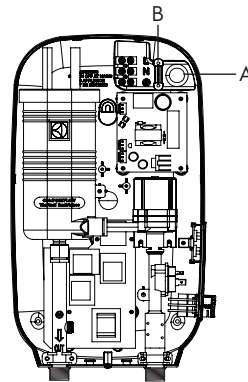

3. INSTALLATION(Continued)

3. Connect the mains cable to the Terminal Block as follows:

BROWN or RED --LIVE (L)
 BLUE or BLACK --NEUTRAL (N)
 GREEN or GREEN/YELLOW --EARTH (⊕)

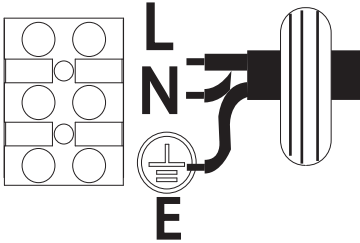

4. Reconnect the temperature display cable to the Main Control PCB at the back of the front cover. Clamp the cable to the correct position.

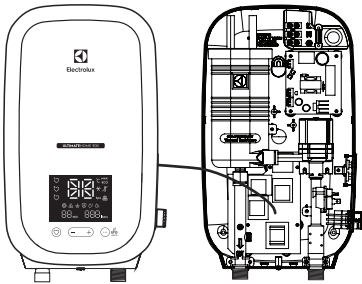

5. Check if the wiring connection is correct.

For first installation, it is advised to check for earth connection of the water heater.

Earth light will light up if wire connection is properly done. If the earth light does not light up, installer needs to check the following.

- Ensure Live and Neutral wire are fixed in correct position
- Ensure Earth wire connection is properly fixed

If earth light still does not light up, please contact electrician to check household earth connection.

6. Reinstall screw A

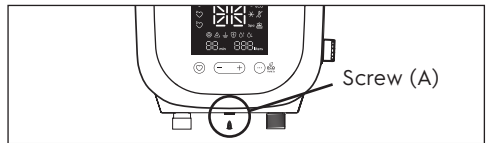
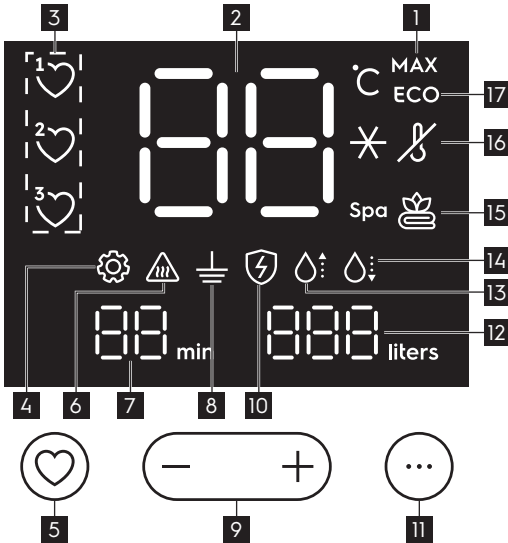

TABLE 1 - CABLE SIZE TABLE

Voltage (AC)	Power (kW)	Current (A)	Conduit Cable (Rigid cable)	Flexible Cable	On/Off Switch (a)	Fuse / MCB (A)
220V ~ 50/60 Hz	2.4	10.9	1.5 ~ 4.0 mm ²	1.5 ~ 2.5 mm ²	20	20
	3.5	15.9	1.5 ~ 4.0 mm ²	1.5 ~ 2.5 mm ²	20	20
	3.8	17.3	2.5 ~ 6.0 mm ²	2.5 ~ 4.0 mm ²	20	20
	4.5	20.5	2.5 ~ 6.0 mm ²	2.5 ~ 4.0 mm ²	32	32
	4.8	21.8	2.5 ~ 6.0 mm ²	2.5 ~ 4.0 mm ²	32	32
	6.0	27.3	4.0 ~ 10.0 mm ²	4.0 ~ 6.0 mm ²	32	32
240V ~ 50/60 Hz (Malaysia Model)	3.6	15.0	4.0 mm ²	4.0 mm ²	25	25

4. USAGE INSTRUCTION

Display Icon Identification



1. Maximum Power Icon
2. Temperature Display
3. Favorite Icons
4. Setting Icon
5. Favorite button
6. Overheat Icon
7. Time Usage Display
8. Earth Icon
9. Temperature adjustment buttons
10. ELCB (Earth Leakage Circuit Breaker) Icon
11. Mode button
12. Water Usage Display
13. Pump Icon*
14. Low Water Pressure Icon
15. Spa icon
16. Cold Shower Icon
17. ECO Icon

*Pump icon is for models with pump feature only

Self-Check:

Each time the power supply is switched on, the unit conducts a self-check. The Earth Icon and ELCB (Earth Leakage Circuit Breaker) Icon will light up sequentially. The Temperature Display will then show "OK" for 5 seconds to indicate that the unit has been self-checked.

After the self check, the Earth Icon and ELCB (Earth Leakage Circuit Breaker) Icon will remain lit. The temperature display will be off. If there is any issue, the Temperature Display will show an error code. Refer to Error codes section for more details.

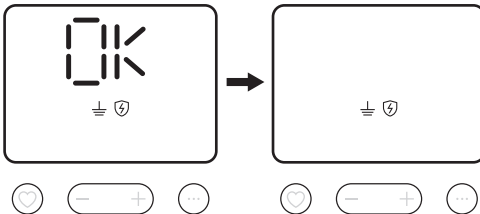

Warm Shower:

Turn on the water supply with the power on. The temperature display will show the last used temperature setting, and the buttons will light up. Adjust the set temperature using the "+" or

"-" buttons within the range of 32°C to 45°C.

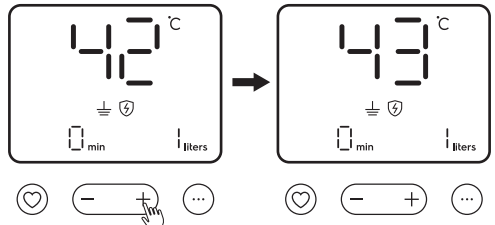

If the actual power reaching the maximum power, the MAX icon will blink.

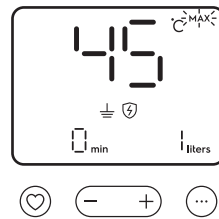

4. USAGE INSTRUCTION(Continued)

If the set temperature reaches 32°C and the "-" button is pressed again, the Cold Shower icon will light up, indicating that the heater will stop heating the water to provide a cold shower experience.

In the event of overheating, the Overheat icon will light up as a warning.

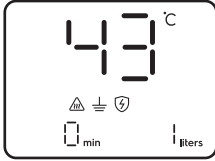

Note: the display temperature is setting temperature, not actual temperature

If the incoming water supply is too cold or the flow rate of water is too high, the shower water might not reach the desired temperature even the "MAX" icon is blinking. In such cases, adjusting the 3-in-1 Stop Valve to reduce the water flow rate is recommended to achieve the desired showering temperature. It's advised to maintain a flow rate below 6 liters per minute.

If the water flow rate is too low, the heater may not be activated properly, resulting in inadequate heating.

It's important to switch off the power supply after using the shower to conserve energy and ensure safety.

Cold Shower:

Tap or hold the "-" button until the Cold Shower icon lights up to activate this mode.

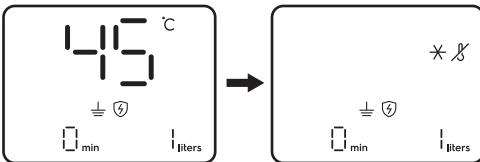

Alternatively, tapping the mode button will cycle through "cold shower," "Spa," and "heat shower" modes.

The device will work for cold showers even if the external power switch is turned off.

To exit the cold shower mode and resume heating the water, simply tap the "+" button on

the control panel of the unit. This action will deactivate the cold shower mode, and the heater will start functioning again to provide warm water for your shower.

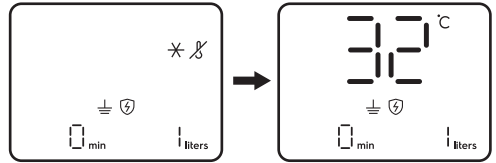

Spa Mode:

In Spa mode, the heater operates in warm and cold intervals every 30 seconds. Select Spa mode by tapping the mode button. Adjust the set temperature within the range of 32°C to 45°C.

In the Spa mode, if you continuously tap the "-" button to decrease the temperature, it will stop at 32°C and will not cycle to the cold shower mode. This means that in Spa mode, the temperature setting will not go below 32°C, ensuring that the water remains at a comfortable temperature for a relaxing spa experience.

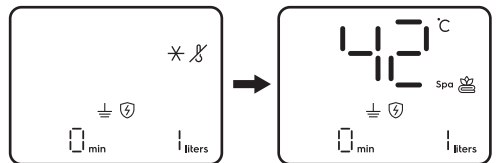

ECO Feature:

To activate ECO, tap and hold the mode button for 2 seconds. The ECO indicator will light up. The ECO feature limits the set temperature to between 32°C to 42°C to reduce power consumption. The ECO feature operates independently to save power consumption up to 10%. When activated, it can be used simultaneously with "Cold Shower" mode, "Spa" mode, or "Saved Favorite" settings. To deactivate the ECO mode, simply tap and hold the mode button for 2 seconds. This will turn off the ECO feature, allowing the water heater to operate at its standard power consumption level.

4. USAGE INSTRUCTION(Continued)

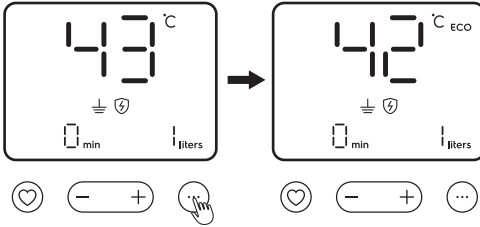

Favorites Setting:

Save favorite temperature settings by tapping the "Favorite" button and adjusting the temperature using the "+" or "-" buttons. Hold the "Favorite" button for 2 seconds to save the setting. Once saved, a confirmation beep will sound once from the water heater, indicating that the temperature adjustment has been successfully saved as a favorite setting.

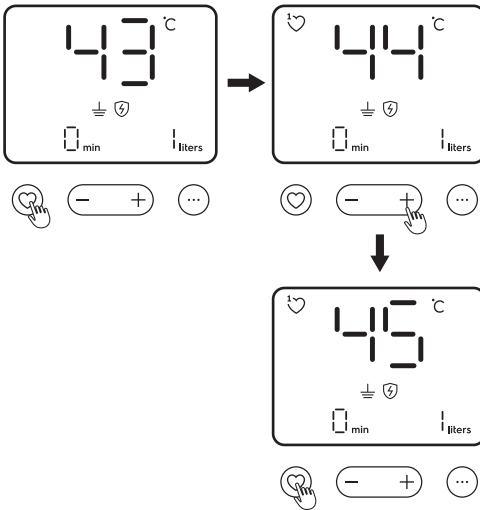

Note: If the temperature for the selected favorite is set but the user does not tap and hold to save within 1 minute, the selected "Favorite" icon will turn off, indicating that the new temperature was not saved under the selected favorite.

Please note that it is only possible to save temperature values between 32°C and 45°C. Users cannot save settings for "Cold Shower," "Spa," or "ECO" modes. But Favorite can be used at the same time with "Eco mode" as long as the saved favorite temperature is lower than 43°C.

If a user selects a saved favorite temperature of 43°C, 44°C, or 45°C and the ECO mode is turned on, ECO mode will automatically turn off for the duration of using this saved favorite temperature. ECO mode will revert back to its previous state after exiting the favorite temperature setting.

Timer/Water Usage:

After the water regulator is initially turned on, the timer and water usage display will begin counting and show the timer and water usage. During the shower, if the water regulator is turned off, only the water usage will be paused. It will resume once the water regulator is turned back on, while the timer will continue counting throughout the entire shower session. The counting values will be saved for 15 minutes and will reset 15 minutes after the water flow has been shut off or the power has been turned off.

Without setting a limit reminder, when it reaches the maximum digit display, it will stay at the maximum value and keep blinking. The maximum digit display for the timer is 99 minutes, and for water usage, it's 999 liters.

To set a reminder:

Tap and hold the "+" and "-" buttons simultaneously for 2 seconds to enter the setting mode. A buzzer sound will beep once. As a confirmation, the "Setting" icon will light up, along with the set timer/usage info. The "Favorite" button will turn off.

The timer will show "--" blinking, and water usage will show "---".

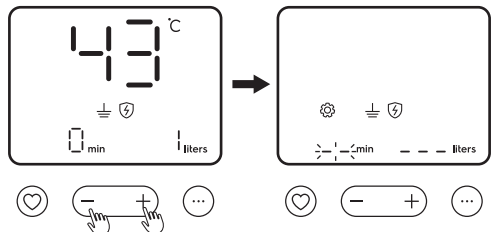

4. USAGE INSTRUCTION(Continued)

Use the "+" and "-" buttons to set the timer reminder. The maximum timer to set is 30 minutes. Once the preferred timing is set, the Mode button will start blinking. Tap the "Mode" button to confirm. If the timer setting is not desired, leave it blank.

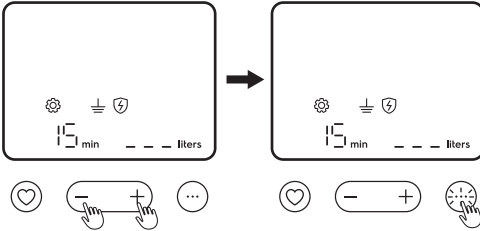

The "Mode" button will light up solid. The water usage digit will show "---" blinking. Use the "+" and "-" buttons to set the water usage reminder. The maximum liters to set is 200 liters. Once the preferred maximum water usage reminder is set, the "Mode" button will start blinking. Tap the "Mode" button to confirm. If the water usage setting is not desired, leave it blank.

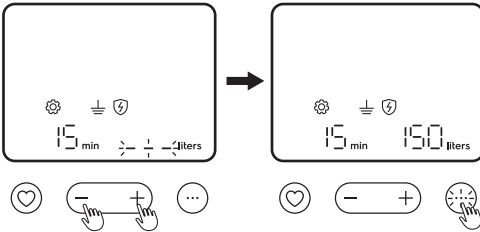

Tap the "Mode" button to confirm. The display will show "SET", and all LED buttons will turn off for 2 seconds and then return to the previous screen.

When the timer or water usage reaches the set limit, the number will blink three times, accompanied by two buzzer beeps. However, the counting will continue.

To turn off the timer/water usage info, tap and hold the "Favorite" and "Mode" buttons together for 2 seconds. A buzzer sound will beep once as a confirmation.

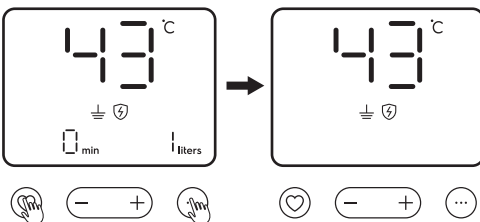

To turn back on the water usage info, tap and hold the "Favorite" and "Mode" buttons together for 2 seconds. A buzzer sound will beep once as a confirmation.

Note: When turning on the timer/water usage info again, it will reset the value to a new start.

Low Water Pressure Icon:

The "Low Water Pressure" icon will blink if the water pressure is low, and the heater will be turned off.

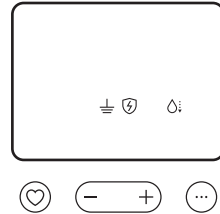

Pump feature (For model with pump feature only)

Basic Pump Function

Turn on the Pump Control Knob to increase the water flow rate when necessary. You may adjust the pump speed until the desired water flow rate and shower temperature is obtained.

Booster Pump Function

If the power supply is ON, and the water flow rate is not sufficient to activate the flow sensor, the Booster Pump Function can be useful to help increase the incoming water flow rate.

Turn the pump knob to OFF position, then turn to MAX position, the Booster Pump Function will be activated to increase the incoming water flow rate. If the increased water flow can be maintained above the flow sensor activation level, the Electric Water Heater will resume working continuously as normal. If the increased water flow cannot be maintained above the flow sensor activation level, the Booster Pump Function will be auto OFF, and the Electric Water Heater will not be able to function normally due to the incoming flow rate being too low. (If the water flow is too low, the pump feature cannot be activated after the Booster Pump Function. It is advisable to avoid applying the Booster Pump Function to increase the water flow rate more than 3 times of each showering).

4. USAGE INSTRUCTION(Continued)

The "pump" icon will be lightened up on the display when the pump is turned on.

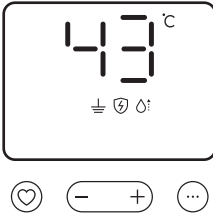



Built-in ELCB Check:

Before test, ensure that the external switch is turned on and the water regulator is turned off. Press "Test" button on the right side of the

water heater to simulate electricity leakage to start test. If the ELCB is normal, all the 4 touch button lights will light off while the "ELCB" icon blinking and show "E1" on the display without blinking.

Press "Reset" button, the unit will run a self-check (refer to Self Check section in page 11)

If there is any issue detected during the test, an error code will be displayed on the screen along with the specific icon blinking. The error codes could be "E1", "E2", or "E4", indicating different types of issues.

Error code	Possible reason
 Display shows "E1" together with "ELCB" icons blinking.	Electrical leak can be triggered at any time during usage or standby
 Display shows "E2"	Problem with thermistor
 Display shows "E4" together with "ELCB" icons blinking	ELCB (Earth Leakage Circuit Breaker) having problem during performing testing

If any issue occurs, turn off the mains supply and turn it on again. If the issue persists, contact local Electrolux Service or authorized service technicians.

Shower Accessory Usage

3 spray shower head have 3 spray patterns:



5 spray shower head have 5 spray patterns:

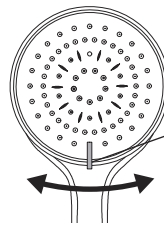
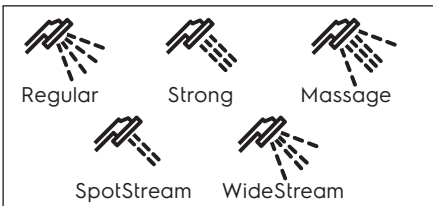

Move the control tab left or right to change different spray patterns.

4. USAGE INSTRUCTION(Continued)

Shower Holder Adjust (For models with slider Rail only)

Press and hold the Adjustment button to adjust the height of the shower holder.

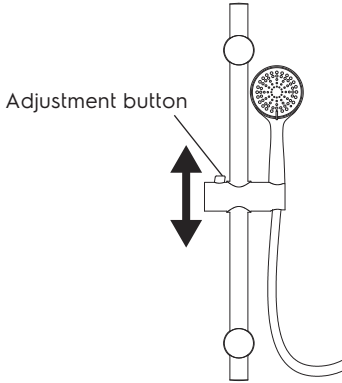

Rain Shower/Shower Head (For models with rain shower accessory only)

Change between the rain shower head and hand shower head by the Selector Valve.

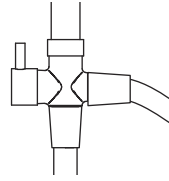

5. MAINTENANCE

Read the section **“SAFETY INFORMATION”** first.

1. TEST THE ‘ELCB (Earth Leakage Circuit Breaker)’ REGULARLY.

This procedure is highly recommended to test at least once a month. Refer to the **“Check the Built-in ELCB”** for the testing procedure.

2. CLEAN THE FILTER REGULARLY

Turn off the water supply before removing the filter.

Clean the Mesh Filter regularly to prevent blockage. Remove the Built-in Filter by turning its cap anticlockwise. Whenever needed, flush the internal strainer with water to remove any trapped sediments. Whenever fixing back the Built-In Filter, beware of the alignment of Internal Strainer. Use the protruded guideline within Stop Valve to position the Internal Strainer.

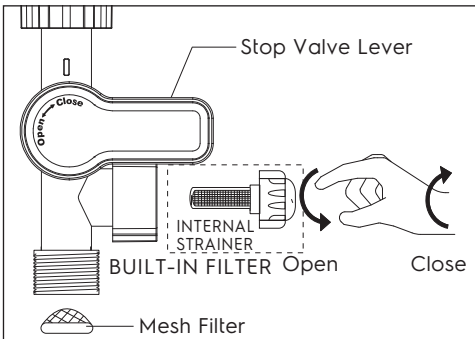

Clean the Hand shower Head holes using the soft brush from time to time. (Recommended once a week)

Note: Take care not to damage the holes of the Hand shower Head during cleaning.

WARNING!

If the Earth/ELCB (Earth Leakage Circuit Breaker) Indicator does not go off when you press the ELCB (Earth Leakage Circuit Breaker) Test Button, switch OFF the mains supply and contact Electrolux Consumer Care Centre for repair service. Special skill is required for repairing. NEVER try to repair the unit by yourself.

CLEANING PRECAUTION!

Do not use thinner, alcohol, petrol, or any other organic solutions to clean the set. **Use only a damp cloth with mild detergent.**

Do not spray on the unit.



6. WIRING DIAGRAM

UH900 series with ELCB (Earth Leakage Circuit Breaker), with display, no pump models

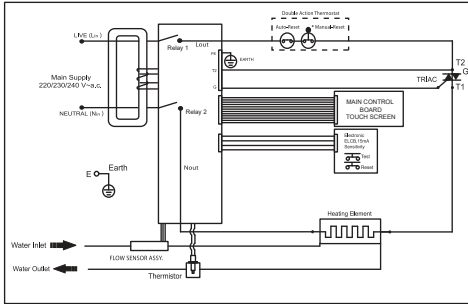

UH900 series with ELCB (Earth Leakage Circuit Breaker), with display, with pump models

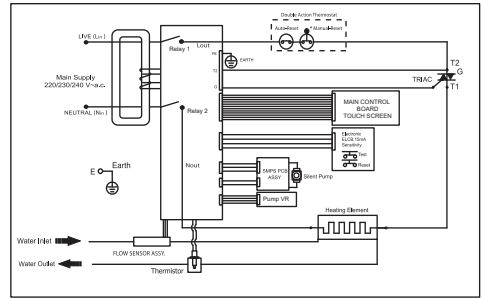

UH900 series with ELCB (Earth Leakage Circuit Breaker), with display, with pump EMC models

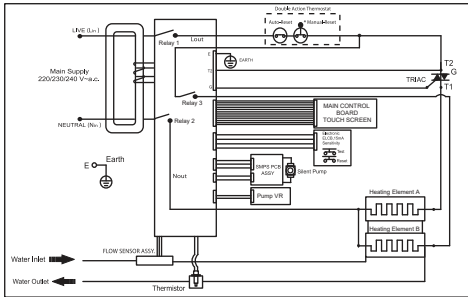

7. Electrical and Recycled Plastic Specification

PRODUCT TYPE (Rated Power)	2.4kW, 3.8kW, 4.5kW,	4.8kW,	3.6kW
POWER SUPPLY	220V a.c. 50/60Hz	220V a.c. 50/60Hz	240V a.c. 50/60Hz
Min. WATER FLOW RATE	2.0 Litre / min	2.2 Litre / min	2.0 Litre / min
Min. INLET WATER PRESSURE	0.1 Bar (10 kPa; 1.45 psi)		
Max. INLET WATER PRESSURE	6.0 Bar (0.6 MPa; 87.02 psi)		
WATER CONNECTION	1/2" BSP SINGLE POINT SYSTEM		
DIMENSIONS	Pump models: 218 (W) X 373 (H) X 76 (T) mm No Pump models: 209 (W) X 373 (H) X 76 (T) mm		
Recycled plastic % from all plastics used	EWE381SX1G6(62%), EWE481SX1G6(62%), EWE451SB-G6(49%), EWE361SB-G7(49%), EWE241SX-G6(51%)		

Note: The specification, actual product's cosmetic design and accessories parts shown are correct at the time of printing and may be subjected to change without prior notice.

Recycled plastic calculation does not include electrical components and accessories.

WE'RE THINKING OF YOU

Thank you for purchasing an Electrolux appliance. You've chosen a product that brings with it decades of professional experience and innovation. In genius and stylish, it has been designed with you in mind. So whenever you use it, you can be safe in knowledge that you'll get great results every time. Welcome to Electrolux.

Visit our website to:



Get usage advice, brochures, trouble shooter, service information:
www.electrolux.com



Register your product for better service:
www.registerelectrolux.com



Buy Accessories, Consumables and Original spare parts for your appliance:
www.electrolux.com/shop

CONSUMER CARE AND SERVICE

We recommend the use of original spare parts. When contacting Service, ensure that you have the following data available.

The information can be found on the rating plate. Model, PNC, Serial Number. (Right side of unit).

 Warning/ Caution-Safety information.

 General information and tips.

 Environmental information.

Subject to change without notice.

CONSUMER CARE

Indonesia

Hotline service: 08041119999

PT. Electrolux Indonesia

Jalan Tanah Abang II Nomor 42,
Desa/Kelurahan Petojo Selatan,
Kec. Gambir, Kota Adm. Jakarta Pusat,
Provinsi DKI Jakarta, Kode Pos: 10160
Email: customercareID@electrolux.com
SMS & WA : 0812.8088.8863

Malaysia

Consumer Care Center Tel: 1300-88-11-22
Electrolux Home Appliances Sdn. Bhd.
Corporate Office Address: Unit T2-7, 7th Floor,
Tower 2, PJ33,
No. 3, Jalan Semangat, Seksyen 13,
46200 Petaling Jaya, Selangor.
Office Tel : (+60 3) 7843 5999

Office Fax : (+60 3) 7955 5511
Consumer Care Center Address: Lot C6, No.
28, Jalan 15/22, Taman Perindustrian Tiong
Nam, 40200 Shah Alam, Selangor
Consumer Care Center Fax : (+60 3) 5524 2521
Email : malaysia.customercare@electrolux.com

Philippines

Consumer Care Center Toll Free :
1-800-10-845-CARE(2273)
Consumer Care Hotline : (+63 2)
845-CARE(2273)
Electrolux Philippines, Inc.
Unit B 12F Cyber Sigma Bldg, Lawton Avenue,
McKinley West, Taguig, Philippines 1634
Trunkline: +63 2 737- 4757
Website : www.electrolux.com.ph
Email : wecare@electrolux.com

Singapore

Consumer Care Center Tel: (+65) 6727 3699
Electrolux S.E.A. Pte Ltd.
1 Fusionopolis Place,
#07-10 Galaxis, West Lobby
Singapore 138522.
Office Fax : (+65) 6727 3611
Email : customer-care.sin@electrolux.com

Thailand

Consumer Care Tel : (+66 2) 725 9000
Electrolux Thailand Co., Ltd.
Electrolux Building 14th Floor
1910 New Phetchaburi Road,
Bangkapi, Huai Khwang, Bangkok 10310
Office Tel : (+66 2) 7259100
Office Fax : (+66 2) 7259299
Email : customercarethai@electrolux.com

Vietnam

Customer Care Hotline:
1800-58-88-99
Electrolux Vietnam Ltd.
Unit 1,2, Floor 10, Sofic Tower
No. 10 Mai Chi Tho Street – Thu Thiem Urban
Ho Chi Minh City Vietnam
Office Tel : (+84 8) 3910 5465
Office Fax : (+84 8) 3910 5470
Email : vn care@electrolux.com

Hongkong

Service Hotline: (+852) 3193 9888
DCH Electrical Appliances Services Centre
5/F, DCH Building, 20 Kai Cheung Road,
Kowloon Bay, Hong Kong

www.electrolux.com/shop

