

EWV1141AEWA
EWV1042AEWA



| | | | |
|-------|----------------------|--|----|
| EN | WASHER - DRYER | USER MANUAL | 2 |
| VN | MÁY GIẶT SẤY KẾT HỢP | TÀI LIỆU HƯỚNG DẪN SỬ DỤNG | 46 |
| <hr/> | | | |
| | |  WI-FI CONNECTIVITY SETUP | 92 |
| | | THIẾT LẬP KẾT NỐI WI-FI | 92 |

EASY WAY TO REGISTER YOUR PRODUCT WITH YOUR SMARTPHONE

- 1 Photograph** the camera icon located on your product's serial tag, including the 4 dots (⦿).

Easy register with your smartphone

1. Photograph the camera icon, including the 4 dots (⦿).
2. Send it in via Line, Facebook Messenger or go online.

 @eluxreg  eluxreg  eluxreg.com

 Electrolux

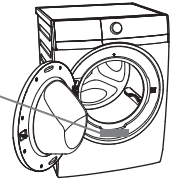

- 2 Send it in** via Line, Facebook Messenger or go online.



@eluxreg



eluxreg



eluxreg.com

- 3 Enjoy** many privileges.*

*Terms and conditions apply.



Electrolux

IMPORTANT INFORMATION THAT MAY IMPACT YOUR MANUFACTURER'S WARRANTY

Adherence to the directions for use in this manual is extremely important for health and safety. Failure to strictly adhere to the requirements in this manual may result in personal injury, property damage and affect your ability to make a claim under the Electrolux manufacturer's warranty provided with your product. Products must be used, installed and operated in accordance with this manual. You may not be able to claim on the Electrolux manufacturer's warranty in the event that your product fault is due to failure to adhere to this manual.

WE'RE THINKING OF YOU

Thank you for purchasing an Electrolux appliance. You've chosen a product that brings with it decades of professional experience and innovation. Ingenious and stylish, it has been designed with you in mind. So whenever you use it, you can be safe in the knowledge that you'll get great results every time. Welcome to Electrolux.

Visit our website to:



Get usage advice, brochures, trouble shooter, service information, buy accessories & spare parts, online product registration : www.electrolux.vn

CUSTOMER CARE AND SERVICE

We recommend the use of original spare parts. When contacting Service, ensure that you have the following data available. The information can be found on the rating plate. Model, PNC, Serial Number.

 Warning / Caution-Safety information.

 General information and tips



 Environmental information.

Subject to change without notice.

| | |
|--------------------------|--|
| RoHS Compliant | Being ensured permissible content limitation of some toxic chemicals (RoHS compliant) |
|--------------------------|--|

CONTENTS

| | |
|--|--|
| <p>1. SAFETY INFORMATION</p> <p>1.1 Conditions Of Use..... 4</p> <p>1.2 Child Safety..... 5</p> <p>1.3 General Safety..... 5</p> <p>1.4 Installation..... 6</p> <p>1.5 Use..... 6</p> <p>2. PRODUCT DESCRIPTION</p> <p>2.1 Parts..... 8</p> <p>2.2 Accessories..... 9</p> <p>2.3 Load Sensor (Only Model EWW1141***)..... 10</p> | <p>3. CONTROL PANEL</p> <p>3.1 Control Panel Description..... 11</p> <p>3.2 Program Chart..... 12</p> <p>3.3 Program Options Compatibility.... 14</p> <p>3.4 Options..... 14</p> <p>3.5 Settings..... 18</p> <p>3.6 Start/Pause (▷) and Add Clothes (☑) Touchpad..... 19</p> <p>4. BEFORE FIRST USE 19</p> |
|--|--|

| | |
|--|----|
| 5. DAILY USE - WASHING (Only) | |
| 5.1 Loading The Laundry..... | 20 |
| 5.2 Using Detergent And Additives ... | 20 |
| 5.3 Options Setting..... | 21 |
| 5.4 Starting A Cycle (▷)..... | 22 |
| 5.5 Interruption Of A Program..... | 22 |
| 5.6 Changing A Program..... | 22 |
| 5.7 Changing The Options | 22 |
| 5.8 Opening The Door..... | 22 |
| 5.9 At The End Of The Program..... | 23 |
| 5.10 When The Washing Program Is Completed, But There Is Water In The Drum..... | 23 |
| 5.11 AUTO Off Mode | 23 |
| 6. DAILY USE - DRYING (Only)..... | 24 |
| 7. DAILY USE - WASHING & DRYING (Non-Stop Program) | |
| 7.1 Washing Program + “Dryness Level” Option | 24 |
| 7.2 Washing Program + “Time Dry  ” Option..... | 25 |
| 8. WASHING HINTS | |
| 8.1 Sorting The Laundry..... | 26 |
| 8.2 Temperatures..... | 26 |
| 8.3 Before Loading The Laundry..... | 26 |
| 8.4 Maximum Loads..... | 26 |
| 8.5 Removing Stains..... | 26 |
| 8.6 Detergents Type And Quantity Of Detergent | 27 |
| 9. DRYING HINTS | |
| 9.1 Preparing The Drying Cycle..... | 28 |
| 9.2 Laundry Not Suitable For Drying. | 28 |
| 9.3 Garment Labels..... | 28 |
| 9.4 Drying Cycle Duration | 28 |
| 9.5 Additional Drying..... | 29 |
| 10. INTERNATIONAL WASH CODE SYMBOLS | 29 |
| 11. CARE AND CLEANING | |
| 11.1 External Cleaning..... | 30 |
| 11.2 Descaling | 30 |
| 11.3 After Each Wash..... | 30 |
| 11.4 Maintenance Wash | 30 |
| 11.5 Cleaning The Dispenser Drawer. | 30 |
| 11.6 Cleaning The Drawer Recess | 31 |
| 11.7 Cleaning The Pump..... | 31 |
| 11.8 Cleaning The Water Inlet Filter ... | 33 |
| 11.9 Frost Precautions..... | 34 |
| 12. TROUBLESHOOTING | |
| 12.1 Possible Failures..... | 35 |
| 12.2 Emergency Door Opening..... | 39 |
| 13. TECHNICAL DATA | 40 |
| 14. INSTALLATION | |
| 14.1 Unpacking | 40 |
| 14.2 Positioning | 42 |
| 14.3 Water Inlet..... | 43 |
| 14.4 Water Drainage..... | 43 |
| 14.5 Electrical Connection..... | 45 |
| 15. ENVIRONMENT CONCERNS | |
| 15.1 Packaging Materials..... | 45 |
| 15.2 Old Machine | 45 |
| 15.3 Ecological Hints..... | 45 |
| 16.  WI-FI CONNECTIVITY SETUP..... | 92 |

1. SAFETY INFORMATION

1.1 Conditions Of Use

This appliance is intended to be used in household and similar applications such as:

- staff kitchen areas in shops, offices and other working environment;
- farm houses;
- by clients in hotels, motels, and other residential type environments;
- bed and breakfast type environments;
- areas for communal use in blocks of flats or in laundrettes.

 **WARNING!** The appliance must not be supplied through an external switching device, such as timer, or connected to a circuit that is regularly switched on and off by utility.

In the interest of your safety and to ensure the correct use, before installing and first using the appliance, read this user manual carefully, including its hints and warnings.

To avoid unnecessary mistakes and accidents, it is important to ensure that all people using the appliance are thoroughly familiar with its operation and safety features.

Save these instructions and make sure that they remain with the appliance if it is moved or sold, so that everyone using it through its life will be properly informed on appliance use and safety.

1.2 Child Safety

- This Washer-Dryer is not intended for use by young children or infirm persons without supervision.
 - Young children should be supervised to ensure that they do not play with the appliance.
 - The packaging components (e.g. plastic film, polystyrene) can be dangerous to children - danger of suffocation! Keep them out of children's reach.
 - Keep all detergents in a safe place out of children's reach.
 - Make sure that children or pets do not climb into the drum.
 - This machine is provided with child safety lock option () to prevent children playing with the control panel. (see page 18)
-

1.3 General Safety

- It is dangerous to alter the specifications or attempt to modify this product in any way.
- During high temperature wash program the door glass may get hot. Do not touch it!
- Make sure that small pets do not climb into the drum. To avoid this, please check inside the drum before using the appliance.
- Any objects such as coins, safety pins, nails, screws, stones or any other hard, sharp material can cause extensive damage and must not be placed into the machine.
- Wash small items such as socks, laces, washable belts etc in a washing bag or pillow case as it is possible for such items to slip down between the tub and the inner drum.
- Only use manufacturer's recommended quantities of fabric softener and detergent. Damage to the fabric or appliance can occur if you exceed the recommended amount.
- Do not use your Washer-Dryer to wash articles with whalebones, material without hems or torn material.
- Always unplug the appliance and turn off the water supply after use, clean and maintenance.
- This appliance is not intended for use by persons (including children) with reduced physical, sensory or mental capabilities, or lack of experience and knowledge, unless they have been given supervision or instruction concerning use of the appliance by a person responsible for their safety.

- Under no circumstances should you attempt to repair the machine yourself. Repairs carried out by inexperienced persons may cause injury or serious malfunctioning. Contact your local Service Centre. Always insist on genuine spare parts.

1.4 Installation

- This appliance is heavy. Care should be taken when moving it.
- When unpacking the appliance, check that it is not damaged. If in doubt, do not use it and contact the Service Centre.
- All packing and transit bolts must be removed before use. Serious damage can occur to the product and to property if this is not adhered to. See relevant section in the user manual.
- After having installed the appliance, check that it is not standing on the inlet and drain hose and the worktop is not pressing the electrical supply cable.
- If the appliance is installed on a carpeted floor, please adjust the feet in order to allow air to circulate freely.
- Always be sure, that there is no water leakage from hoses and their connections after the installation.
- Any plumbing work required to install this appliance should be carried out by a qualified plumber.
- Any electrical work required to install this appliance should be carried out by a qualified electrician.



May cause electric shock! if the machine is not connected to an earthed/ground system. DO NOT touch the wet clothes and metal parts.



For safety reasons do not use double adaptors, extension cords and multi-plug adapters.

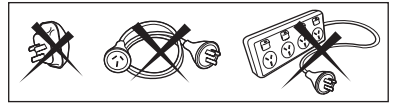

1.5 Use

- Only wash fabrics which are designed to be machine washed. Follow the instructions on each garment label.
- Do not overload the appliance. See the relevant section in the user manual.
- Before washing, ensure that all pockets are empty and buttons and zips are fastened. Avoid washing frayed or torn articles and treat stains such as paint, ink, rust, and grass before washing.
- Garments which have been in contact with volatile petroleum products should not be machine washed. If volatile cleaning fluids are used, care should be taken to ensure that the fluid is removed from the garment before placing in the machine.
- Never pull the power supply cable to remove the plug from the socket; always take hold of the plug itself.
- Never use the Washer-Dryer if the power supply cable, the control panel, the working surface or the base are damaged so that the inside of the Washer-Dryer is accessible.
- As some duvets and eiderdowns should be washed/dried in large commercial machine because of their bulk, please check with the manufacturer of the item before washing/drying in a domestic machine.

- The users should always check that they have not left their gas lighters (disposable or otherwise) in their clothing.
- Never tumble dry items which have had contact with chemicals such as dry cleaning fluid. These are of volatile nature and could cause an explosion. Only tumble dry items which have been washed in water or require airing.
- Plastic detergent dispensers should not remain in the drum during the drying cycle, as the plastic used is not designed to withstand the heat. If you wish to wash-through-to dry you should use the conventional detergent dispenser drawer.
- If it is unavoidable that fabrics contain vegetable or cooking oil or have been contaminated by hair care products be placed in washer-dryer, it should first be washed in hot water with extra detergent - this will reduce, but not eliminate the hazard. The "cool down" cycle of washer-dryer is used to reduce the temperature of the items. It should not be removed from the washer-dryer or piled or stacked while hot.
- Items that have been previously cleaned in, washed in, soaked in or spotted with petrol/gasoline, dry-cleaning solvents or other flammable or explosive substances should not be placed in washer-dryer.



CAUTION!

- Never stop a washer-dryer before the end of the drying cycle unless all items are quickly removed and spread out so that the heat is dissipated.
- Do not dry cloths in washer-dryer with dry clean solvents. Also, do not use laundry enhancement products during the drying cycle.

To minimize the risk of fire in a washer-dryer, the following should be observed:

- Items that have been spotted or soaked with vegetable or cooking oil constitute a fire hazard and should not be placed in a washer-dryer. Oil-affected items can ignite spontaneously, especially when exposed to heat sources such as in washer-dryer. The items become warm, causing an oxidation creates heat.
If the heat cannot escape, the items can become hot enough to catch fire. Piling, stacking or storing oil-affected items can prevent heat from escaping and so create a fire hazard.
- Highly flammable substances commonly used in domestic environments include acetone, denatured alcohol, petrol/gasoline, kerosene, spot removers (some brands), turpentine, waxes and wax removers.
- Items containing foam rubber (also known as latex foam) or similarly textured rubber, like materials should not be dried in a washer-dryer on a heat setting.
- Foam rubber materials can produce fire by spontaneous combustion when heated.
- Fabric softeners or similar products should not be used in a washer-dryer to eliminate the effects of static electricity unless this practice is specifically recommended by the manufacturer of the fabric softener or product.
- Undergarments that contain metal reinforcements should not be placed in a washer-dryer. Damage to the washer-dryer can result if metal reinforcements come loose during drying. When available a drying rack could be used for such items.
- Plastic articles such as shower caps or babies' waterproof napkin covers should not be placed in washer-dryer.

2. PRODUCT DESCRIPTION

2.1 Parts

Worktop

Detergent/Softener
Dispenser
(see page 20)

Control Panel
(see page 11)

Door

Cabinet

Front Panel

Drain Pump Filter
(see page 31)

Level Adjustment
Feet (Front)

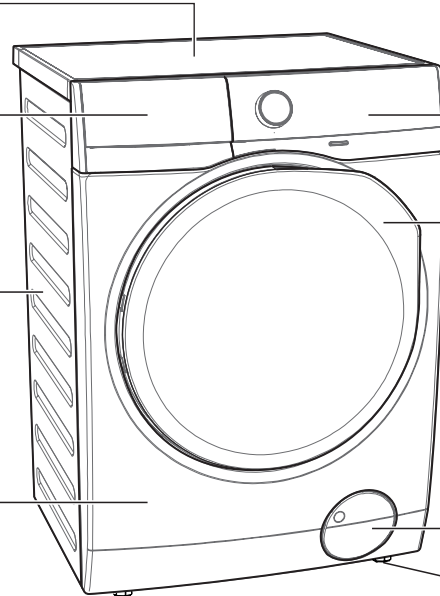

Transit Bolts

Mains Cable

Water Inlet Hose
(see page 43)

Transit Bolts &
Hose Support

Water Drain Hose
(see page 43)

Transit Bolts &
Hose Support

Level Adjustment
Feet (Back)

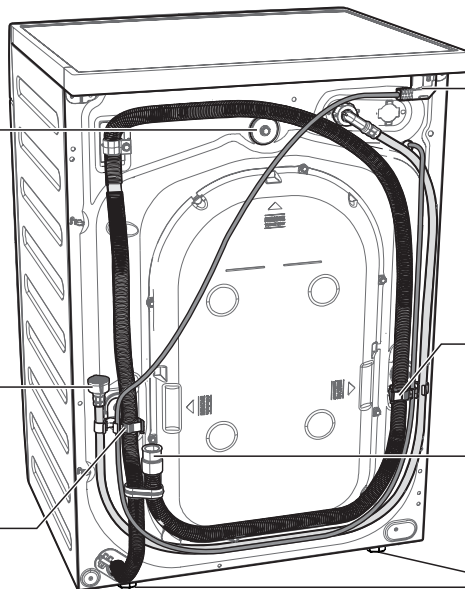

Detergent/Softener Dispenser
(For more informations, see page 20, 30)

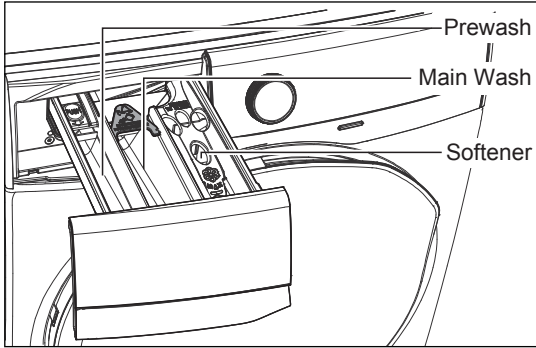

Door (when open)
(for more informations, see page 20)

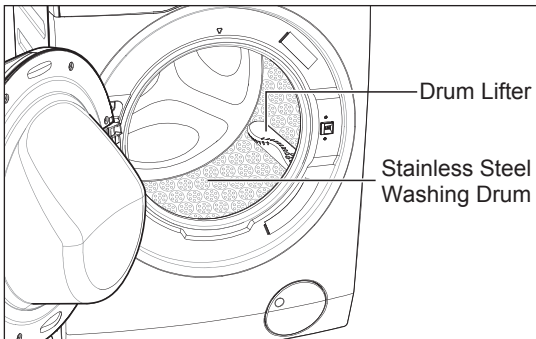

Drain Pump Filter (when open)

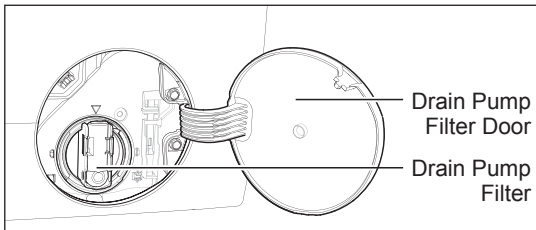

Level Adjustment Feet

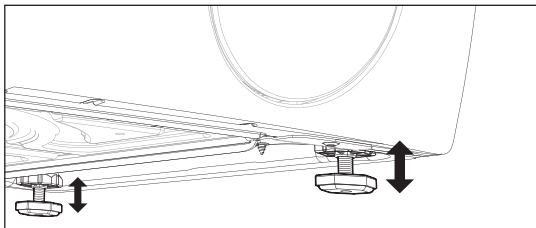

Transit Bolt (when remove)

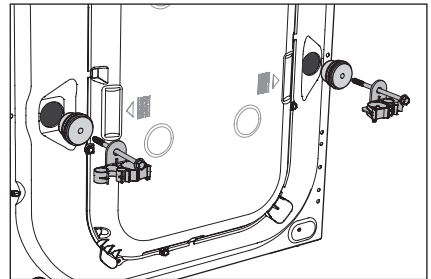
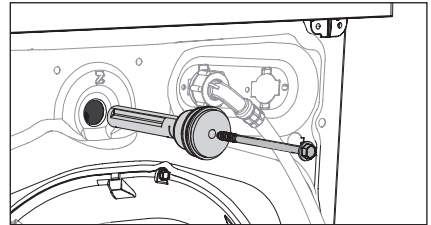

! Transit bolts must be removed before using the appliance.

2.2 Accessories

Plastic Caps

To close the holes on the rear side of the cabinet after the removal of the transit bolts.



Plastic Hose Guide

To connect the drain hose on the edge of a sink.

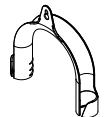

2.3 Load Sensor

(Only Model EWW1141***)

This machine has “Load Sensing Device” which shows how much load you put in the machine and maximum load recommended for selected wash program.

- i** The display shows these indicators when the door is open.
- i** The weight shown on display is an approximate weight only.
- i** For correct operation of the load sensor, activate the appliance and set a wash program **BEFORE** loading the laundry in the drum.

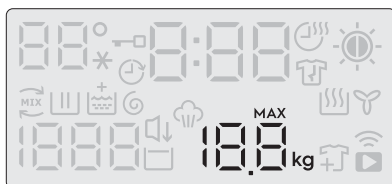

- The display will show “MAX” when max limit is reached for selected program.
 - On the display, the weight of the laundry updates by 0.5 kg steps.
 - The weight is a general indication that changes with the type of the laundry.
 - If you exceed the max weight limit of a program, the symbol “MAX ” will start flashing as long as the load in the drum is more than recommended load, even after the door is closed.
-

3. CONTROL PANEL

3.1 Control Panel Description

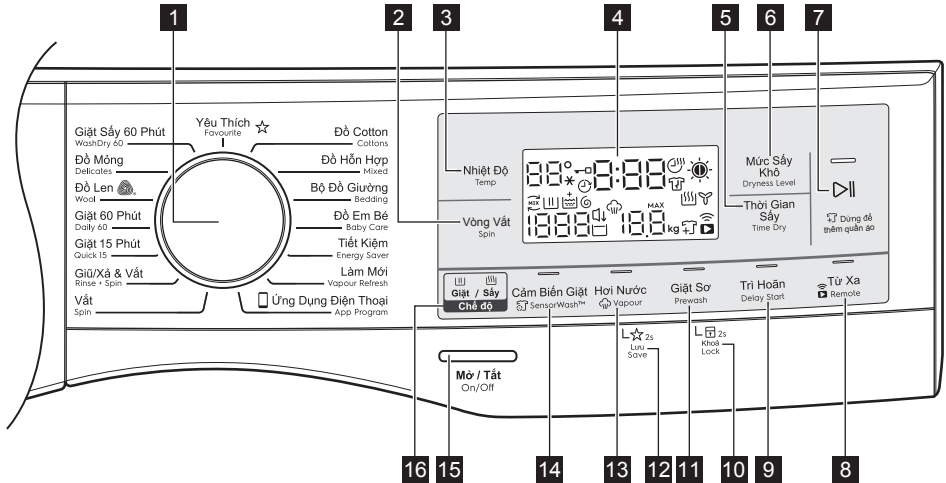



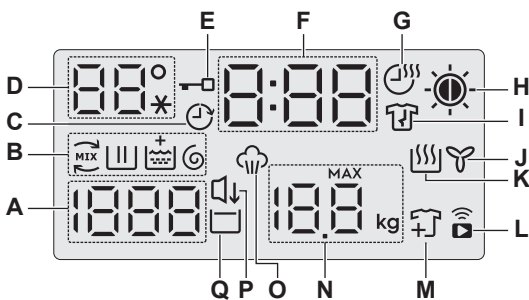

- | | |
|---|--|
| <ul style="list-style-type: none"> 1 Program Selector Knob 2 Spin Selection Touchpad 3 Temperature Selection Touchpad 4 Display 5 Time Dry Touchpad 6 Dryness Level Touchpad 7 Start/Pause and Add Clothes Touchpad 8 Remote Touchpad | <ul style="list-style-type: none"> 9 Delay Start Touchpad 10 Child Lock Option 11 Prewash Touchpad 12 Save Favourite Program Option 13 Vapour Touchpad 14 SensorWash Touchpad 15 On/Off Button 16 Wash/Dry Mode Selection Touchpad |
|---|--|



- | | |
|--|--|
| <ul style="list-style-type: none"> A) Spin Speed B) Program Phase Indication Icon: <ul style="list-style-type: none"> MIX Ultramix Phase Wash Phase Rinse Phase Spin Phase C) Delay Start Icon D) Temperature (✱ corresponds to cold wash) | <ul style="list-style-type: none"> E) Door Lock Icon F) Program Duration G) Time Dry Icon H) Dryness Level Icon <ul style="list-style-type: none"> ☀ Extra Dry ☀ Cupboard Dry I) Anticrease Phase Icon J) Cooling Phase Icon K) Drying Phase Icon L) Remote Icon M) Add Clothes Icon N) Maximum Load Capacity Of Selected Program O) Vapour Phase Icon P) Extra Silent Icon (Only model EWW1141****) Q) Rinse Hold Icon |
|--|--|

3.2 Program Chart

| Program; Temperature range | Max. Spin Speed | Max. Load (Dry Clothes) | | Type of load and soil level |
|---|-----------------------|----------------------------|------|--|
| | | Wash | Dry | |
| Cottons; Cold to 90°C | 1400 rpm | Max. ¹⁾ | 7 kg | White and coloured cotton. |
| Mixed; Cold to 60°C | 1200 rpm | 4 kg | 3 kg | Synthetic or mixed fabric items. |
| Bedding; Cold to 60°C | 800 rpm | 3 kg | – | Special program for one synthetic blanket, duvet, bedspread and so on. |
| Baby Care; Cold to 40°C | 1200 rpm | 4 kg | – | Baby cotton clothes and delicate knitting items with normal soil. |
| Energy Saver; 40°C and 60°C ²⁾ | 1400 rpm | Max. | 7 kg | White and colourfast cotton. Set this program to have a good washing results and decrease the energy consumption. The time of the washing program is extended. |
| Vapour Refresh | – | 1.5 kg | – | This cycle removes odours and helps to dewrinkle the laundry.  Do not add detergent. |
|  App Program | – | – | – | You can send any additional program from Mobile Application to store at this program position and can recall to using it everytime when you rotate program knob to this position. This can be done through the App.  Program “Outdoor” is the default stored program from factory. |
| Spin | 1400 rpm | Max. | 7 kg | To spin the laundry and drain the water in the drum. |
| Rinse + Spin | 1400 rpm | Max. | 7 kg | To rinse and spin the laundry. |
| Quick 15; 30°C | 800 rpm | 1.5 kg | – | Lightly soiled synthetics or mixed fabrics. |
| Daily 60; 30°C to 60°C | 1400 rpm | 5.5 kg | 4 kg | Coloured cotton e.g. shirts, blouses, towels and undergarments with normal level of soil. |
| Wool  ; Cold to 40°C | 1200 rpm | 2 kg | 1 kg | Specially tested program for woollen garments bearing the “Pure new woollen, non-shrink, machine washable” label. |

| Program; Temperature range | Max. Spin Speed | Max. Load (Dry Clothes) | | Type of load and soil level |
|-----------------------------------|-----------------------|----------------------------|------|---|
| | | Wash | Dry | |
| Delicates; Cold to 40°C | 1200 rpm | 4 kg | – | Delicate fabrics such as acrylics, viscose, polyester items. |
| WashDry 60; 30°C, 40°C | 1200 rpm | 1 kg | 1 kg | Non-Stop washing and drying program for 3 - 5 shirts with lightly soil. |
| Favourite | – | – | – | Recall you favourite program. |

1) Maximum capacity depended on model:

Model EWW1141AEWA : 11 kg

Model EWW1042AEWA : 10 kg

2) Energy Saver Program with 60degC option selected is recommended for a full load of normally soiled cotton and is the Energy and Water rating label program

Woolmark Apparel Care - Blue



The wool wash cycle of this machine has been approved by The Woolmark Company for the washing of wool garments labelled as “hand wash” provided that the garments are washed according to the instructions issued by the manufacturer of this machine.

Follow the garment care label for drying and other laundry instructions. M1361

The Woolmark symbol is a Certification mark in many countries.

3.3 Program Options Compatibility

| Program | Option | | | | | | | | | |
|----------------|---------|------------|----------------------------|-----------------------------|------------------------|-------------|---------|----------------------|-------------|--|
| | No Spin | Rinse Hold | Extra ³⁾ Silent | Dryness ²⁾ Level | Time ²⁾ Dry | Delay Start | Prewash | Vapour ¹⁾ | Sensor Wash | |
| Cottons | ○ | ○ | ○ | ○ | ○ | ○ | ○ | ○ | ○ | |
| Mixed | ○ | ○ | ○ | ○ ⁴⁾ | ○ | ○ | ○ | ○ | ○ | |
| Bedding | ○ | × | × | × | × | ○ | × | ○ | ○ | |
| Baby Care | ○ | ○ | ○ | × | × | ○ | ○ | ○ | ○ | |
| Energy Saver | ○ | ○ | × | ○ | ○ | ○ | ○ | ○ | × | |
| Vapour Refresh | × | × | × | × | × | ○ | × | ○ | × | |
| App Program | – | – | – | – | – | – | – | – | – | |
| Spin | ○ | × | × | ○ | ○ | ○ | × | × | × | |
| Rinse + Spin | ○ | ○ | × | ○ | ○ | ○ | × | × | × | |
| Quick 15 | ○ | ○ | × | × | × | ○ | × | × | × | |
| Daily 60 | ○ | ○ | × | ○ | ○ | ○ | × | × | × | |
| Wool | ○ | ○ | ○ | × | ○ | ○ | × | × | × | |
| Delicates | ○ | ○ | ○ | × | × | ○ | ○ | ○ | ○ | |
| WashDry 60 | × | × | × | × | × | ○ | × | × | × | |
| Favourite | – | – | – | – | – | – | – | – | – | |

1) Vapour option can be combined with temperature 40°C to 90°C only.

2) Do not select a spin speed LOWER than that proposed by the appliance to avoid a too long drying time so saving energy. In any case the reduction of the spin speed is only possible after selecting drying.

3) "Extra Silent" option, only in model EWW1141***.

4) This program can select only "Cupboard Dry" option.

3.4 Options

Wash/Dry Mode Touchpad

This touchpad is used to select Program Mode of your machine. Program modes available are:

- Wash Only Mode (default)
- Wash and Dry Mode
- Dry Only Mode

If a mode is not compatible with program selected, the symbol "– – –" will flash on display along with buzzer sound.

Changing a running program mode is **possible only by switching off** the machine.

Temperature Touchpad

Press this touchpad repeatedly to increase or decrease the wash temperature if you want your laundry to be washed at a temperature different from the one proposed by the Washer-Dryer.

Spin Selection Touchpad

Press this touchpad repeatedly to increase or decrease the spin speed or select Rinse Hold, if you want your laundry to be spun at a speed different from the one proposed by the Washer-Dryer.

- **No Spin (---)**

No spin option eliminates all the spin phases and increase the number of rinses.

- **Rinse Hold (□)**

By selecting this option the water of the last rinse is not emptied out and the drum turns regularly to prevent the laundry creases.

The door is still locked to indicate that the water must be emptied out.

 The door stays locked with the water in the drum. To continue the cycle, you must press ▷|| (Start/Pause).

- **Extra Silent (↓) (Only Model EWW1141***)**

By selecting this option, the machine will not drain the water of the last rinse to avoid wrinkling the laundry. All spinning phases are suppressed. This washing cycle is very quiet, and can be selected at night or other appropriate times.

 The door stays locked with the water in the drum. To continue the cycle, you must press ▷|| (Start/Pause).

SensorWash™ () Touchpad

Select “SensorWash™” option to turn ON the sensors for the dirt and detergent residue.

 The “SensorWash” is switched ON by default. If you want to turn OFF the sensor press this touchpad once. (Please see the table “Program Options Compatibility” for which programs can be used with this option.)

When using this option, machine will automatically check the dirt level and detergent residue in your laundry. It will automatically adjust the washing time and numbers of rinses according to the load to make sure that your clothes are really clean.

The SensorWash technology consist of 2 different sensors for detection:

1) The 1st Turbidity sensor detects the dirt level at the start of cycle and automatically calculates the actual time needed to remove the level of dirt in the wash; from low dirt levels all the way to the maximum dirt level.

 The initial time displayed on the control panel indicates the time needed for the maximum dirt level.

2) The 2nd Conductivity sensor will check the amount of detergent residue after the first rinse and the machine will calculate the optimum number of rinses (Maximum of 2 additional rinses) needed to make sure that the detergent residue is properly removed.

 Please see details of detergent usage at “Detergents Type and Quantity of Detergent”

Vapour (☁️) Touchpad

Select this option to add approximately 30 minutes of tumbling in vapour during the wash cycle. Vapour helps open fabric fibers up to allow laundry additives to release tough stains. The indicator of this option will be on.

- Vapour may not necessarily be visible inside the drum during a vapour wash cycle. Vapour is created below the drum and allowed to naturally rise into the clothes.
- Vapour may not be present during the entire vapour wash cycle.
- Vapour function is more effective with half load.
- At the end of the Vapour cycle, the clothes will be warmer, softer and detached from the drum.

NOTE

If Vapour option is selected, rinse temperatures will be elevated.

During a vapour cycle, you may notice vapour exiting from the drain hose of the Washer-Dryer, this is normal and there is no cause for alarm.

Prewash Touchpad

Select this option if you wish your laundry to be pre-washed before the main wash. Use this option for heavy soil. The indicator of this option will be on.

When you set this function, put the detergent into the “” compartment. This function increases the program duration.

Delay Start Touchpad

This option makes it possible to delay the start of the program by 30 min, 60 min or 90 min and then by every hour from 2 to 20 hours. The delay you have selected is indicated on the display. The end time will increase in order to show you the selected delay.

You must select this option after you have set the program and before you press the Start/Pause button.

If you wish to add laundry in the machine during the delay time, press Start/Pause touchpad to put the machine in pause mode. Add laundry, close the door and press Start/Pause touchpad again.

You can cancel the delay time at any moment, by pressing “Delay Start” touchpad repeatedly till the display shows delay time “”, then press the Start/Pause touchpad.

Remote (📶) Touchpad

This option allows you to connect washer-dryer to Wi-Fi network and to link it to your smart phone.

By this functionality you can receive notifications, control and monitor your washer-dryer from your mobile devices.

To connect the washer-dryer with your smart phone you need:

- Wireless network at home with internet connection enabled.
- Smart Phone connected to wireless network.

Wi-Fi specification requirements:



| | |
|------------------|---|
| Frequency | 2.4 GHz according to local country regulation |
| Protocol | IEEE 802.11b/g/n |
| Max Power | According to local country regulation |

 When the door is open, remote functions are disabled.

Connection setting and other suggestions please refer to attached leaflet of this user manual.

Dryness Level Touchpad

Press this touchpad to set dryness level using auto sensing feature. The display will show the selected option.

- Extra dry 
- Cupboard dry 
- Iron dry 

NOTE

- Dryness level settings are based on wash program selected.

- The final time value is the total duration of the washing + detachment + drying cycles, calculated on a default load size.
- At the end of the program the appliance performs the anti-crease phase for approximately 10 minutes. During this time, the display will show time remaining “E 10” and door is locked “→”.

 If you wish to open the door during the anti-crease phase or interrupt it, press Start/Pause touchpad.

Dryness Option Guidelines:

| Level of dryness | Type of fabric | Load |
|---|---|------------|
| Extra Dry Ideal for towels or similar | Cotton and linen (bathrobes, bath towels, etc) | up to 7 kg |
| Cupboard Dry Suitable for items to put away without ironing | Cotton and linen (bathrobes, bath towels, etc) | up to 7 kg |
| | Synthetics and mixed fabrics (jumpers, blouses, underwear, household linen) | up to 3 kg |
| Iron Dry Suitable for ironing | Cotton and linen (sheets, tablecloths, shirts, etc.) | up to 7 kg |

Time Dry () Touchpad

If you wish to carry out a timed drying program, keep pressing this touchpad until the desired time is reached.

NOTE

- Maximum allowable timed drying changes based on wash program selected.

- The final time value is the total duration of the washing + detachment + drying cycles.
- At the end of the program the appliance performs the anti-crease phase for approximately 10 minutes. During this time, the display will show time remaining “E 10” and door is locked “→”.

 If you wish to open the door during the anti-crease phase or interrupt it, press Start/Pause touchpad.

Dry Time Option Guidelines:

| Type of fabric | Load (kg) | Spin Speed (rpm) | Suggested Times (Hrs) |
|---|-----------|------------------|-----------------------|
| Cotton and linen (bathrobes, bath towels, etc.). | 5 - 7 | 1400 | 3 - 4 |
| | 3 - 5 | 1400 | 2 - 3 |
| | 2 - 3 | 1400 | 1 - 2 |
| Synthetic or mixed fabric items (jumpers, blouses, underwear, household linen, etc.). | 3 | 1200 | 2 - 3 |
| | 1 | 1200 | 1 |
| Wool and hand washable wool. | 1 | 1200 | 2 |

Duration of the drying cycle

The drying time can vary according to :

- the final spin speed;
- dryness level (Extra Dry or Cupboard Dry or Iron Dry);
- the type of laundry;
- the size of load.



Fibre residue

After drying fluffy fabrics, such as new towels, it is advisable to perform a Rinse program to ensure that any residue that may remain in the tub is completely removed and does not stick to garments dried afterwards. After each drying cycle, clean the drain pump filter. Please refer to care and cleaning in section 11 “CARE AND CLEANING”.

Additional drying

Should the laundry still be too wet at the end of the program, set another short drying cycle.

- The final part of a washer- dryer cycle occurs without heat (cool down cycle). This ensures the laundry will be left at a low temperature.

• **WARNING!**

To prevent the formation of creases or shrinking of fabrics, avoid excessive drying.

3.5 Settings

Save Favourite (☆) Program

Program settings that are frequently used can be saved (e.g. Cotton, 60°C, 1200 rpm, with Prewash and Vapour).

To program/re-program Favourite with your own selections and save them, proceed as follows:

1. Put machine in Stand-By mode.
2. Select your desired program settings.
3. To save favourite program, press and hold “Vapour ” touchpad about 2 seconds and you will hear “Bip, Bip” sound and “Favourite” LED is flashing.

To recall the favourite wash program, turn selector knob to “Favourite ☆” program. You will get acknowledgement on the screen when the Favourite program is loaded.

-  App Program cycle cannot be saved as a Favourite on the appliance.



Child Safety Lock () Option

Your appliance is provided with CHILD SAFETY LOCK which permits you to leave the appliance unsupervised with the door closed without having to worry that children might be injured by or cause damage to the appliance.

-  Set this option after pressing the Start/Pause touchpad.

To set “Child Lock” option:

- To activate the function, press and hold “Prewash” touchpad about 2 seconds until the display shows the icon “”.

-  If you press any touchpad while Child Lock is activated, the icon “” will flash on display 3 times along with buzzer sound.

-  The touchpads are locked (except for the On/Off button).

-  This function remains enabled even after the appliance is switched off.

- To deactivate the function, press and hold “Prewash” touchpad about 2 seconds until the display shows the icon “”.

Enabling/Disabling End-Of-Wash Buzzer

This setting permits you to either enable or disable the buzzer at the end of the program. As an example, you might wish to disable this buzzer when you start a wash when going to bed, so that when the wash finished approximately 1 hour later, it will not disturb you through the night.

i Error warning beeps such as critical faults are not disabled.

- To disable the buzzer sound, press “SensorWash (🧼)” and “Vapour (☁️)” touchpads at the same time about 3 seconds, the icon “🔊” will show on display along with buzzer sound.
- To return to default configuration press these 2 touchpads at the same time about 3 seconds, the icon “🔊” will show on display along with buzzer sound.

3.6 Start/Pause (▶️||) and Add Clothes (👕) Touchpad

This touchpad has 2 functions:

1. Start/Pause (▶️||)

After you have selected the desired program and options, press this touchpad to start the machine. The Start/Pause pilot light will stop flashing and remain lit until the water level is above the bottom edge of the door then pilot light goes OFF.

If you have selected a “Delay Start” option, the countdown will begin and will be shown on the display.

To interrupt a program which is running, press this touchpad to pause the machine, the Start/Pause pilot light flashes.

To restart the program from the point at which it was interrupted, press this touchpad again, the Start/Pause pilot light will stop flashing.

2. Add Clothes (👕)

i You can only add clothes when the icon “👕” shown on the display.

To add clothes:

1. Pressing the “Start/Pause” touchpad to pause the program.
2. Wait for the machine to come to a complete stop before opening the door (wait for door lock “🔒” icon to turn off).
3. Add clothing and close the door.
4. Resume the program by pressing “Start/Pause” touchpad again.

4. BEFORE FIRST USE

i NOTE

During installation or before first use you may observe some water in the machine. This is a residual water left in the machine after a full functional test in the factory to ensure the machine is delivered to customers in perfect working order and is no cause for concern.

1. Ensure that the electrical and water connections comply with the installation instructions.
2. Put 2 litres of water in the detergent compartment for washing phase. This activates the drain system.

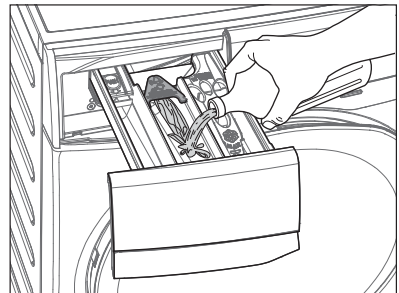

3. Select a Cottons cycle at 90 °C, without any laundry in the machine, to remove any manufacturing residue from the drum and tub then start the machine.

5. DAILY USE - WASHING (Only)

5.1 Loading The Laundry

1. Turn the water tap on.
2. Connect the main plug to the main socket.
3. Press the On/Off button to turn on the Washer-Dryer. Turn the knob to set a program. The Washer-Dryer will propose a temperature and automatically select the spin value provided for the program you have chosen.

The selector knob can be turned either clockwise or counter-clockwise.

4. Check and remove objects (if there are any) that could be trapped in the fold.

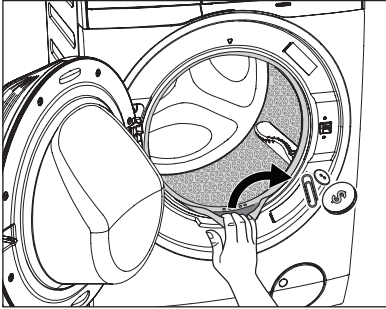

5. Place the laundry in the drum, one item at a time, shaking them out as much as possible. (Refer to page 26 "WASHING HINTS")

6. Close the door.



Make sure that no laundry remains between the seal and the door.

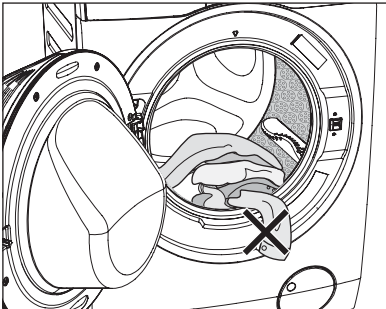

5.2 Using Detergent And Additives

i Please read "Detergents Type and Quantity of Detergent" on page 27 before use.

1. Detergent Dispenser Drawer

The detergent dispenser is divided into three compartments.

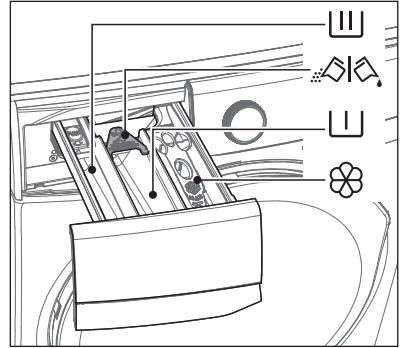

- Compartment "PREWASH"

This compartment is only used for detergent when a "Prewash" option is selected.

- Compartment "MAIN WASH"

This compartment is used for detergent on all programs.

Detergent flap

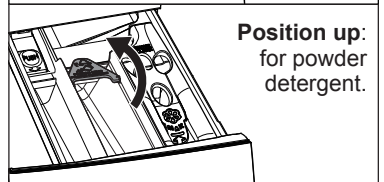
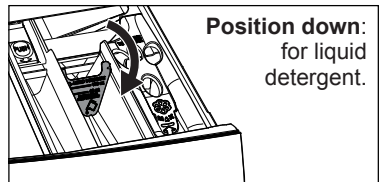



- Compartment "SOFTENER"

This compartment is used for fabric conditioner and starching agent.

i **When you use the liquid detergent**

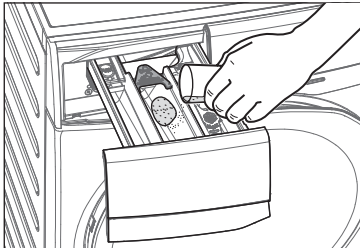
- Do not use gelatinous or thick liquid detergents.
 - Do not put more liquid than the maximum level.
 - Do not set the “Prewash” phase.
 - Do not set the “Delay Start”.
2. Measure out the detergent and the fabric softener;
- Pull out the dispenser drawer until it stops.
 - Measure out the amount of detergent required, pour it into the main wash compartment .



- If you wish to carry out the “Prewash” phase, pour it into the compartment marked .

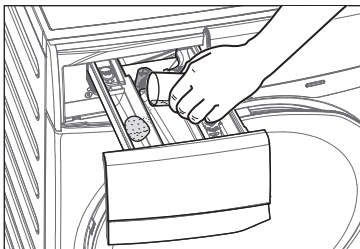

- If required, pour fabric softener into the compartment marked .

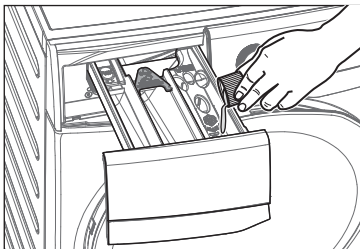

- Close the drawer gently.

i **NOTE**

The softener amount used must not exceed the “MAX” mark in the drawer.

If you use thick softeners it is recommended to dilute with water.

i **NOTE**

Residues of detergent, softener and water may remain in the dispenser. It is recommended to clean the dispenser regularly to remove any residue.

5.3 Options Setting

1. If you want your laundry to be spun or use temperature different from the one proposed by the Washer-Dryer, press “Spin” and “Temp” touchpads repeatedly to change the spin speed and temperature.

Press the option touchpads, if you want your laundry to be washed with special functions.

i **NOTE**

- Different functions can be combined which is dependent on the program selected.
 - If an option is not compatible with the program selected, the symbol “- - -” will flash on display along with buzzer sound.
2. If you want to delay the start of the program, press the “Delay Start” touchpad repeatedly to choose your Washer-Dryer delay time.

5.4 Starting A Cycle (▷||)

To start a program, press the Start/Pause touchpad. The corresponding pilot light will stop flashing and a default program duration will be displayed on the screen.

After approx. 15 minutes from the start of a program:

- The appliance will automatically adjust the selected program duration according to the type and size of the load.
- The display will show adjusted program duration.

NOTE

If you press any touchpad while a program is operating, the symbol “- - -” will flash on display along with buzzer sound. (except Start/Pause touchpad and On/Off button)

5.5 Interruption Of A Program

- To pause, press Start/ Pause. The indicator will start flashing.
- Press the Start/Pause again. The program will continue.

5.6 Changing A Program

Changing a running program is possible **only by switching off** the appliance.

- Press the “On/Off” button to cancel the program and to turn off the appliance.
- Press the “On/Off” button again to start the appliance.

Now you can set a new wash program and change any available options. Press Start/Pause to start the new program.

NOTE

The appliance will not drain the water (except programs; Vapour Refresh, Spin, Rinse + Spin).

5.7 Changing The Options



It may be possible to change some of the options after a program has started.

1. Press the touchpad Start/Pause. The indicator will start flashing.
2. If available change the options that you wish.
3. Press Start/Pause again. The program will continue.

5.8 Opening The Door

While a program or the Delay Start is operating, the appliance door is locked and the display shows the indicator “”. First, set the machine to PAUSE by pressing the “Start/Pause” touchpad. Wait until the door lock indicator goes off, then the door can be opened.

If the door lock indicator “” does not disappear, this means that the machine is already heating and the water level is above the bottom edge of the door or the drum is turning. In this case the door CAN NOT be opened. If you need to open it, you must drain the water to open the door.

In case of Remote () function is activated, when program cycle end and anticrease phase is complete. The door will remain locked for 5 minutes, if you want to open the door at that time, press Remote () touchpad once to turned off function then the door is unlocked.



In case of emergency please refer to “Emergency door opening” on page 39.

5.9 At The End Of The Program To drain the water:

- The appliance stops automatically.
- The acoustic signal will operate.
- The display will show “E r d”.
- The indicator of the touchpad Start/Pause goes off.
- The door lock indicator “ ” goes off.
- Remove the laundry from the appliance. Make sure that the drum is empty.
- Keep the door partly open, to prevent the mildew and odours.
- Turn off the water tap.

NOTE

At the end of the program, the time remaining can suddenly decrease from 7 minutes or less to 0 due to the overestimated total program time during the load sensing phase. In some cases (with perfectly balanced load) the program time can be shorter than the time estimated after the load sensing phase is completed. This is a normal behavior of the machine and not a cause for concern as it does not compromise its performance.

5.10 When The Washing Program Is Completed, But There Is Water In The Drum

(Option “Rinse Hold  ” or “Extra Silent  (only model EWW1141****)” is used)

- The drum turns regularly to prevent the creases in the laundry.
- The indicator “Start/Pause” flashes to remind you to drain the water.
- The door lock indicator “ ” is on. The door stays locked.

 **You must drain the water to open the door.**

1. Press the “Start/Pause  ” touchpad. The appliance drains the water and spins with the maximum spin speed for selected program.

Alternatively, before pressing the “Start/Pause” touchpad, you can press the “Spin” touchpad to change the spin speed. You can select “No Spin (---)”, if you want the machine to only drain the water.

2. When the program is completed and the door lock indicator “ ” goes off, you can open the door.
3. Press the “On/Off” button to deactivate the appliance.

NOTE

After approximately 18 hours, if you do not press Start/Pause touchpad, the appliance will drain and spin automatically (except for “Wool” program) .

5.11 AUTO Off Mode

The AUTO Off mode automatically deactivates the appliance to decrease the energy consumption when:

- You do not press any buttons for 5 minutes before you press “Start/Pause”.
 - Press the “On/Off” button to activate the appliance again.
- After 5 minutes from the end of the washing program.
 - Press the “On/Off” button to reactivate the appliance. Display will show the end of the last wash.
 - Press any touchpad again to show the last wash program.

6. DAILY USE - DRYING (Only)

1. Press the On/Off button to turn on the machine.



The water tap must be open and the drain hose must be positioned in the sink or connected to the drain pipe.

2. Load the laundry. Make sure the load size does not exceed the maximum drying capacity of the machine.
3. Turn the knob to set a wash program which can select drying option (refer to Program Chart on page 12), according to your clothes then press **Wash/Dry Mode** touchpad to switch your machine to **Dry Only** () mode.
4. If you wish to select an automatic drying, press the “Dryness Level” option until the icon corresponding to the required dryness level appears on the display. (see page 17)
5. If you wish to select a timed drying, press the “Time Dry” () option repeatedly until desired drying time reached. (see page 17)
6. Press “Start/Pause” () touchpad to start the program. The time remaining is updated every minute.

7. At the end of the program :

- The acoustic signal will operate.
- The display will show “ ” and “Anti Crease ()” icon is lit.
- The door lock indicator “ ” is still on.
- The appliance will perform the anti-crease phase for approximately 10 minutes.

After anti-crease phase finish, the door lock indicator “ ” goes off. The display will show “ ”.



If you wish to open the door during the anti-crease phase or interrupt it, press Start/Pause touchpad.

8. Press “On/Off” button to switch the machine off.
9. At the end of each drying cycle, the temperature of your clothing will be high. For your safety, please leave the door open to let your clothes cool before removing your laundry.

7. DAILY USE - WASHING & DRYING (Non-Stop Program)

7.1 Washing Program + “Dryness Level” Option

1. Load the laundry and add detergent and fabric softener. Make sure the load size does not exceed the maximum drying capacity of the machine.
2. Turn the knob to set a wash program which can select drying option (refer to Program Chart on page 12), according to your clothes then press **Wash/Dry Mode** touchpad to switch your machine to **Wash and Dry** (/) mode.
3. Select the required options by pressing the relevant touchpads. If possible, do not select a spin speed lower than that proposed by the machine to avoid unnecessary longer drying time therefore saving energy.
4. Set the dryness level by pressing “**Dryness Level**” touchpad. The display will then show the whole duration of wash & dry cycle.



If a program is not compatible with the drying option selected, the symbol “ --- ” will flash on display.

5. Start the program by pressing Start/Pause touchpad. The time remaining is updated every minute on the display.

6. At the end of the program press the On/Off button to switch the machine off.



At the end of each drying cycle, the temperature of your clothing will be high. For your safety, please leave the door open to let your clothes cool before removing your laundry.

i NOTE

- If you wish to open the door during the anti-crease phase or interrupt it, press Start/Pause touchpad.
- Some drying level options are not available for some programs.

- When “Iron Dry ☀️” option is selected, the display time will be adjusted after approximately 15 minutes from the start of the program, based on the laundry type and load size.

The display will show the new adjusted time.

- When “Extra Dry ☀️” or “Cupboard Dry ☀️” is selected the display time will be adjusted towards the end of the drying cycle when machine senses required dryness level has been achieved. In case of laundry quantity lower than maximum load capacity, the time remaining can suddenly decrease from e.g. approximately 50 minutes to 10.

7.2 Washing Program + “Time Dry 🕒” Option

1. Load the laundry and add detergent and fabric softener. Make sure the load size does not exceed the maximum drying capacity of the machine.
2. Turn the knob to set a wash program which can select drying option (refer to Program Chart on page 12), according to your clothes then press **Wash/Dry Mode** touchpad to switch your machine to **Wash and Dry (🕒 / 🕒) mode**.
3. Select the required options by pressing the relevant touchpads. If possible, do not select a spin speed lower than that proposed by the machine to avoid unnecessary longer drying time therefore saving energy.
4. Set the drying time by pressing “Time Dry 🕒” touchpad repeatedly until desired drying time reached. The display will then show the whole duration of wash & dry cycle.



If a program is not compatible with the drying option selected, the symbol “ --- ” will flash on display.

5. Start the program by pressing Start/Pause touchpad. The time remaining is updated every minute on the display.

6. At the end of the program press the On/Off button to switch the machine off.



At the end of each drying cycle, the temperature of your clothing will be high. For your safety, please leave the door open to let your clothes cool before removing your laundry.

i NOTE

- If you wish to open the door during the anti-crease phase or interrupt it, press Start/Pause touchpad.
- If you set only 10 minutes of drying, the appliance performs only a Cooling (🌀) phase.

8. WASHING HINTS

8.1 Sorting The Laundry

Follow the wash code symbols on each garment label and the manufacturer's washing instructions. Sort the laundry as follows: whites, coloureds, synthetics, delicates, woollens.

8.2 Temperatures

| Temp | Soil level |
|----------------------|---|
| 90°C | For normally soiled white cottons and linen (e.g. tea cloths, towels, tablecloths, sheets...). |
| 60°C 50°C | For normally soiled, colourfast garments (e.g. shirts, night dresses, pajamas....) in linen, cotton or synthetic fibres and for lightly soiled white cotton (e.g. underwear). |
| 40°C 30°C Cold | For delicate items (e.g. net curtains), mixed laundry including synthetic fibres and woollens bearing the label pure new wool, machine washable, non-shrink. |

8.3 Before Loading The Laundry

- Make sure that no metal objects are left in the laundry (e.g. coin, hair clips, safety pins, pins).



- Button up pillowcases, close zip fasteners, hooks and poppers. Tie any belts or long tapes.

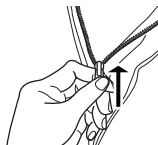

- Wash bras, pantyhose and other delicates in a mesh laundry bag, which you can purchase from your supermarket.



- Make sure that you wash lint collectors separately from lint producers.
- Never wash whites and coloured fabrics together. Whites may lose their "whiteness" in the wash.
- New coloured items may run in the first wash; they should therefore be washed separately the first time.
- Remove persistent stains before washing.
- Rub particularly soiled areas with a special detergent or detergent paste. Treat curtains with special care. Remove hooks or tie them up in a bag or a net.

8.4 Maximum Loads

Recommended loads are indicated in the program charts on page 12.

General rules:

| Clothes Load | Quantity |
|-------------------------------|---------------------------------------|
| Cotton, linen | drum full but not too tightly packed; |
| Synthetics | drum no more than half full; |
| Delicate fabrics and woollens | drum no more than one third full. |

Washing a maximum load makes the most efficient use of water and energy. For heavily soiled laundry, reduce the load size.

8.5 Removing Stains

Stubborn stains may not be removed by just water and detergent. It is therefore advisable to treat them prior to washing.

Blood: treat fresh stains with cold water. For dried stains, soak overnight in water with a special detergent then rub in the soap and water.

Oil based paint: moisten with benzine stain remover, lay the garment on a soft cloth and dab the stain; treat several times.

Dried grease stains: moisten with turpentine, lay the garment on a soft surface and dab the stain with the fingertips and a cotton cloth.

Rust: oxalic acid dissolved in hot water or a rust removing product used in cold water. Be careful with rust stains which are not recent since the cellulose structure will already have been damaged and the fabric tends to hole.

Mould stains: treat with bleach, rinse well (whites and fast coloureds only).

Grass: soap lightly and treat with bleach (whites and fast coloureds only).

Ball point pen and glue: moisten with acetone (*), lay the garment on a soft cloth and dab the stain.

Lipstick: moisten with acetone (*) as above, then treat stains with methylated spirits. Remove any residual marks from white fabrics with bleach.

Red wine: soak in water and detergent, rinse and treat with acetic or citric acid, then rinse. Treat any residual marks with bleach.

Ink: depending on the type of ink, moisten the fabric first with acetone (*), then with acetic acid; treat any residual marks on white fabrics with bleach and then rinse thoroughly.

Tar stains: first treat with stain remover, methylated spirits or benzine, then rub with detergent paste.

(*) do not use acetone on artificial silk.

8.6 Detergents Type And Quantity Of Detergent

Low sudsing detergent is required for this Washer-Dryer to prevent oversudsing problems, unsatisfactory washing result and harm to the machine.

Low sudsing detergents designed for front load washing machines are labelled "Front Loading", "high efficiency", "HE", such as Cold Power for Front Loaders or "Matic".

Do not use wrong types of detergent, such as Top Loading, Handwash detergent or Soap-Based products in your frontload Washer-Dryer. This can result in excessive suds, longer cycle time, low spin speeds, poor rinsing and overloading of the motor.

Quantity of detergent to be used

The choice of detergent and use of correct quantities not only affects your wash performance, but also helps to avoid waste and protect the environment. Although biodegradable detergents contain substances which in large quantities can upset the delicate balance of nature.

The choice and quantity of detergent will depend on ;

- type of fabric (delicates, woollens, cottons, etc.) ;
- the colour of clothes ;
- size of the load ;
- degree of soil ;
- wash temperature ; and
- hardness of the water used.

Water hardness is classified by so-called "degrees" of hardness.

Information on hardness of the water in your area can be obtained from the relevant water supply company, or from your local authority.

You may have to try using the detergent quantity as per manufacturers' instructions then compare the wash result to the list below and adjust the amount of detergent for your future washes accordingly.

Not enough detergent causes:

- the washload to turn grey,
- greasy clothes.

Too much detergent causes:

- oversudsing,
- reduced washing effect,
- inadequate rinsing.

Use less detergent if:

- you are washing a small load,
- the laundry is lightly soiled,
- large amounts of foam during washing.

9. DRYING HINTS

9.1 Preparing The Drying Cycle

As a dryer, the appliance works on condensation principle.

Therefore, the water tap must be open and the drain hose must drain water into a sink or into the drain pipe, even during the drying cycle.

**ATTENTION!**

Before starting the drying program. Make sure the load size does not exceed the maximum drying capacity of the machine. In order to obtain good performances. (Refer page 12)

9.2 Laundry Not Suitable For Drying

- Particularly delicate items such as synthetic curtains, woollen and silk, garments with metal inserts, nylon stockings, bulky garments such as anoraks, bed covers, quilts, sleeping bags and duvets must not be machine dried.
- Avoid drying dark clothes with light coloured fluffy items such as towels as these can attract fluff.
- Remove the laundry when the appliance has finished drying.
- To avoid a static charge when drying is completed, use either a fabric softener when you are washing the laundry or a fabric conditioner specifically for tumble dryers.
- Garments padded with foam-rubber or materials similar to foam-rubber must not be machine dried; they represent a fire hazard.

- Also, fabrics containing residue of setting lotions or hair sprays, nail solvents or similar solutions must not be machine dried to avoid formation of harmful vapours.

The detergent and any additives must be placed in the appropriate compartments of the dispenser drawer before starting the wash program.



If using liquid detergents, a program without prewash must be selected.

9.3 Garment Labels

For drying, follow the indications given on the manufacturer's labels:



= May be tumble dried



= Drying at high temperature



= Drying at reduced temperature



= Do not tumble dry.

9.4 Drying Cycle Duration

The drying time may vary depending on:

- speed of the final spin;
- dryness level required (Extra dry, Cupboard dry, Iron dry);
- type of laundry;
- weight of the load.

The average drying time for a timed drying are indicated in the "Time Dry " option (see page 17). The experience will help you to dry your laundry in a more suitable way according to the different fabrics.

9.5 Additional Drying

































If the laundry is still damp at the end of the drying program, select a short drying cycle again.

 **WARNING!**

Do not over dry the laundry in order to avoid creasing of fabrics or garments shrinking.

10. INTERNATIONAL WASH CODE SYMBOLS

 These symbols appear on fabric labels, in order to help you choose the best way to treat your laundry.

| | | | | | | |
|--|---|--|---|---|---|--|
|  Energetic wash |  Max. wash temperature 95 °C |  Max. wash temperature 60 °C |  Max. wash temperature 40 °C |  Max. wash temperature 30 °C |  Hand wash |  DO NOT wash at all |
|  Delicate wash | |  |   |  | | |
|  Bleaching |  Bleach in cold water | | |  DO NOT bleach | | |
|  Ironing |  Hot iron max. 200 °C |  Warm iron max. 150 °C | |  Lukewarm iron max. 110 °C |  DO NOT iron | |
|  Dry cleaning |  Dry cleaning in all solvents |  Dry cleaning in perchlorethylene, petrol, pure alcohol, R 111 & R 113 | |  Dry cleaning in petrol, pure alcohol and R 113 |  DO NOT dry clean | |
|  Drying |  Flat |  On the line |  On clothes hanger |  High temperature  Low temperature Tumble dry |  DO NOT tumble dry | |

11. CARE AND CLEANING

WARNING!

You must **DISCONNECT** the appliance from the electricity supply, before you can carry out any cleaning or maintenance work.

11.1 External Cleaning

Clean the appliance only with soap and warm water. Fully dry all the surfaces.

CAUTION!

Do not use alcohol, solvents or chemical products.

11.2 Descaling

The water we use normally contains lime. It is a good idea to periodically use a water softening powder in the machine.

Do this separately from any laundry washing, and according to the softening powder manufacturer's instructions.

This will help to prevent the formation of lime deposits.

11.3 After Each Wash

Leave the door open for a while. This helps to prevent mould and stagnant smells forming inside the appliance.

Keeping the door open after a wash will also help to preserve the door seal.

11.4 Maintenance Wash

With the use of low temperature washes it is possible to get a build up of residues inside the drum.

We recommend that a maintenance wash be performed on a regular basis.

To run a maintenance wash:

- The drum should be empty of laundry.
- Select the hottest Cottons wash program.
- Press Start/Pause to start the program.

11.5 Cleaning The Dispenser Drawer

The washing powder and additive dispenser drawer should be cleaned regularly.

Remove the drawer by pressing the catch downwards and by pulling it out.

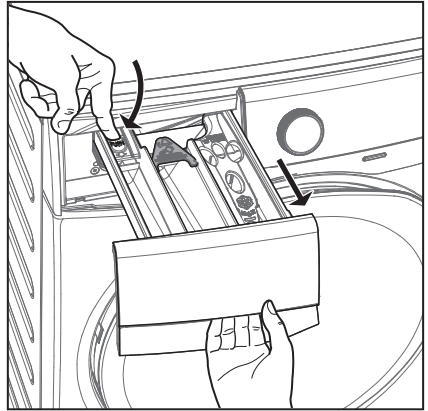

To aid cleaning, the top part of the additive compartment should be removed.

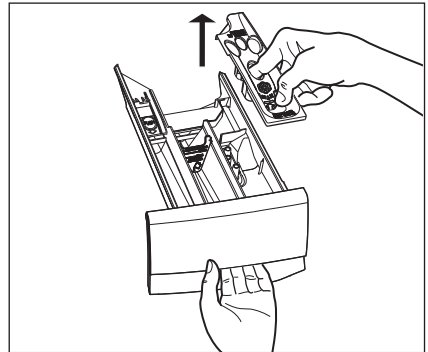

Flush it out under a tap to remove any traces of accumulated powder.

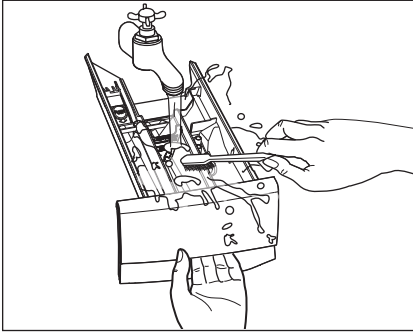

11.6 Cleaning The Drawer Recess

Having removed the drawer, use a small brush to clean the recess, ensuring that all washing powder residue is removed from the upper and lower part of the recess. Replace the drawer and run the rinse program without any clothes in the drum.

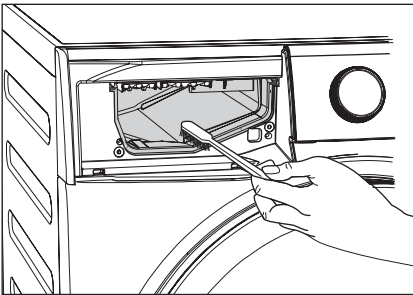

11.7 Cleaning The Pump

i Regularly examine the drain pump and make sure that it is clean.

Clean the pump if:

- The appliance does not drain the water.
- The drum cannot turn.
- The appliance makes an unusual noise because of the blockage of the drain pump.
- The display shows an alarm code because of the problem with water drain.

! WARNING!

1. Disconnect the mains plug from the mains socket.
2. Do not remove the filter while the appliance is operating. Do not clean the drain pump if the water in the appliance is hot. The water must be cold before you clean the drain pump.

To clean the drain pump:

1. Open the drain pump door.

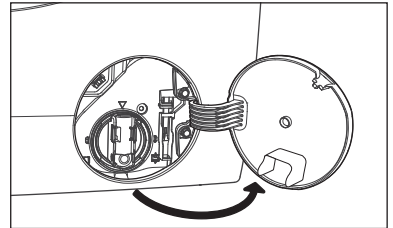
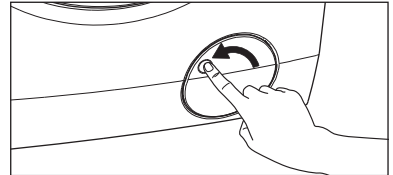

2. Place a suitable water container below the recess of the drain pump to collect the water that flows out.

Press the two levers and pull forward the drainage duct to let the water flow out.

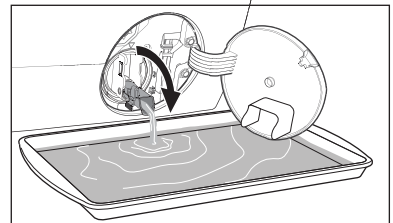
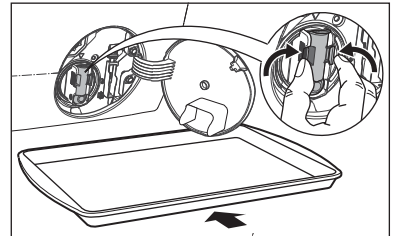

3. When the container is full of water, put the drainage duct back again and empty the container. Do step 2, 3 again and again until no more water flows out from the drain pump.

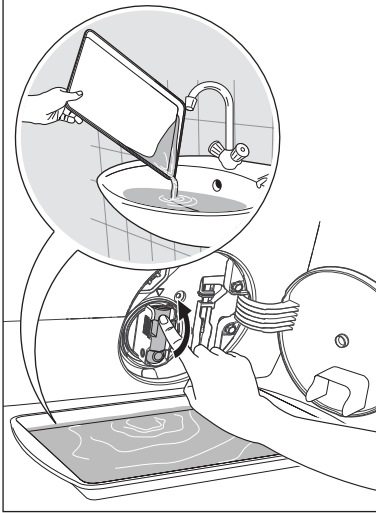

4. Push back the drainage duct and turn the filter counter-clockwise to remove it.

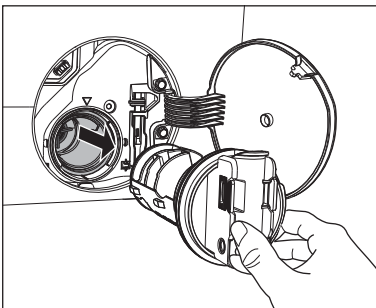
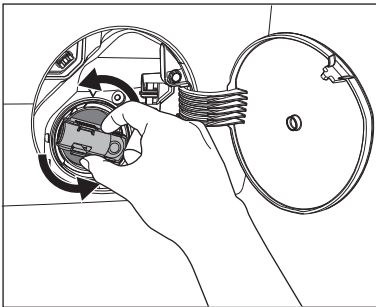

5. Remove fluff and objects from the pump (if there are any).

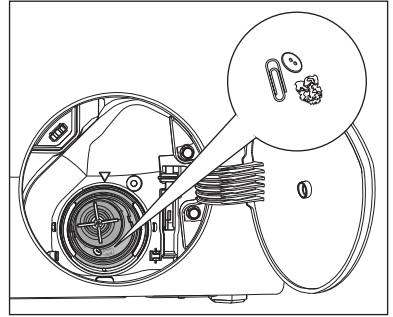

6. Make sure that the impeller of the pump can turn. If this does not occur, contact the service centre.

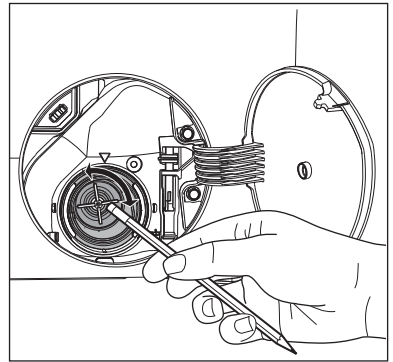

7. Clean the filter under the water tap.

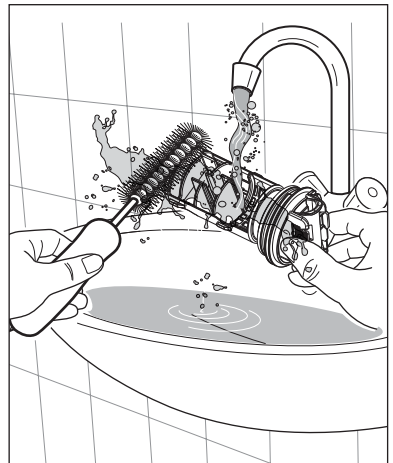

- Put the filter back into the housing with exposed section facing up. Make sure that you correctly tighten the filter to prevent leakages.

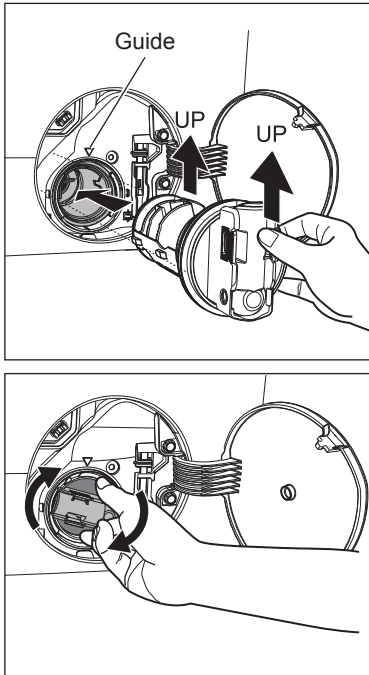

- Close the drain pump door.

11.8 Cleaning The Water Inlet Filter

If your water is very hard or contains traces of lime deposit, the water inlet filter may become clogged. It is therefore a good idea to clean it from time to time.

To clean the water inlet filters:

- Close the water tap.
- Remove the water inlet hose from the water tap.

- Clean the filter in the inlet hose with a stiff brush.

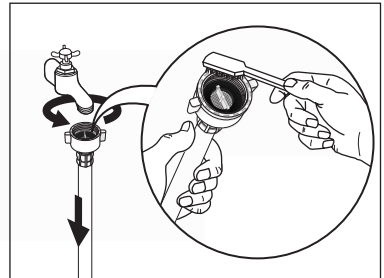

- Remove the inlet hose behind the appliance.

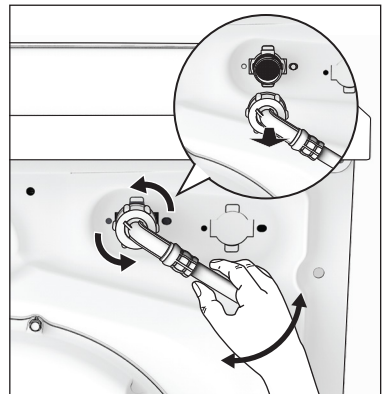

- Clean the filter in the valve with a stiff brush or a towel.

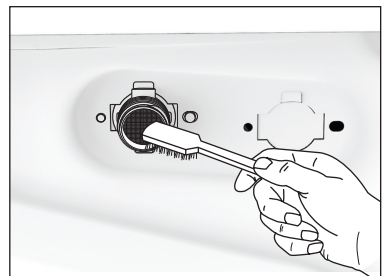

- Install the inlet hose again. Make sure that the couplings are tight to prevent leakages.
- Open the water tap.

11.9 Frost Precautions

If the appliance is installed in an area where the temperature can be less than 0 °C, remove the remaining water from the inlet hose and the drain pump.

Emergency Drain

1. Disconnect the main plug from the main socket. Turn off the water tap.
2. Remove the water inlet hose.
3. Remove the drain hose from the rear support and unhook it from sink or spigot.

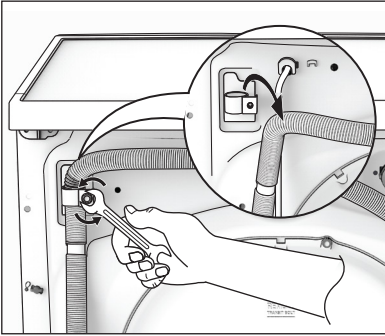

4. Put the end of the drain and inlet hose in a container. Let the water flow out of the hoses.

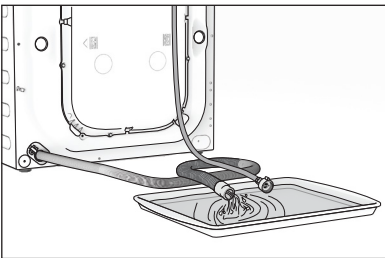

5. When no more water flows, install the inlet hose and the drain hose again.



Make sure that the temperature is more than 0 °C before you use the appliance again.

12. TROUBLESHOOTING

12.1 Possible Failures

Certain problems are due to lack of simple maintenance or oversights, which can be solved easily without calling out an engineer.

Before contacting your local Service Centre, please check troubleshooting.

Once the problem has been eliminated, press the Start/Pause button to restart the program. If after all checks, the problem persists, contact your local Service Centre.



WARNING! Deactivate the appliance before you do the checks.

Alarm Code:

| | |
|------|--|
| E 10 | The appliance does not fill with water properly. |
| E 20 | The appliance does not drain the water. |
| E 40 | The appliance door is open or not closed correctly. Please check the door! |
| E H0 | The main supply is unstable. Wait until the main supply is stable. |
| E 9 | No communication between electronic elements of the appliance. Switch off and switch on again. |
| E A0 | No Registration Data found in machine or Server. |

| Malfunction | Possible cause | Solution |
|--|--|---|
| Machine does not start: | The door has not been closed. (Error code: E 40) | Close the door firmly. |
| | The plug is not properly inserted into the power socket. | Insert the plug into the power socket. |
| | There is no power at the socket. | Please check your domestic electrical installation. |
| | The Start/Pause touchpad has not been pressed. | Press the Start/Pause touchpad. |
| | The "Delay Start" has been selected. | If the laundry are to be washed immediately, cancel the "Delay Start". |
| Machine does not fill the water: | The Main supply is unstable. (If E H0 appears on the display.) | Wait until the main supply is stable. Appliance will start automatically. |
| | The water tap is closed. (Error code: E 10) | Open the water tap. |
| | The inlet hose is squashed or kinked. (Error code: E 10) | Check the inlet hose connection. |
| | The filter in the inlet hose is blocked. (Error code: E 10) | Clean the water inlet hose filter. |
| Machine fills then empties immediately: | The door is not properly closed. (Error code: E 40) | Close the door firmly. |
| | The end of the drain hose is too low. (Error code: E 10) | Refer to relevant paragraph in "water drainage" section. |

| Malfunction | Possible cause | Solution |
|---|---|---|
| Machine does not empty and/or does not spin: | The drain hose is squashed or kinked. (Error code: E20) | Check the drain hose connection. |
| | The drain pump is clogged. (Error code: E20) | Clean the drain filter. |
| | The option "Rinse Hold" has been selected. | Press Start/Pause touchpad to drain the water or select spin program. |
| | The laundry is not evenly distributed in the drum. | Pause the machine and redistribute laundry manually. |
| There is water on the floor: | Too much detergent or unsuitable detergent (creates too much foam) has been used. | Reduce detergent quantity and use correct type of detergent (refer page 27). |
| | Check whether there are any leaks from one of the inlet hose fittings. It is not always easy to see this as the water runs down the hose; check to see if it is damp. | Check the water inlet hose connection. |
| | The drain hose is damaged. | Call Service. |
| Unsatisfactory washing results: | Too little detergent or unsuitable detergent has been used. | Increase detergent quantity or use different detergent (refer page 27). |
| | Stubborn stains have not been treated prior to washing. | Use commercial products to treat the stubborn stains. |
| | The correct temperature was not selected. | Check if you have selected the correct temperature. |
| | Excessive laundry load. | Reduce load. |
| The door will not open: | The program is still running. | Wait until the end of cycle. |
| | There is water in the drum. | You must drain the water to open the door (refer "Opening The Door" on page 22). |
| | This problem may be caused by a failure of the appliance. | Contact Service. If you need to open the door, please read carefully "Emergency door opening" on page 39. |
| Machine vibrates or is noisy: | The transit bolts and packing have not been removed. | Check the correct installation of the appliance. |
| | The support feet have not been adjusted. | Check the correct levelling of the appliance. |

| Malfunction | Possible cause | Solution |
|---|---|--|
| Machine vibrates or is noisy: | The laundry is not evenly distributed in the drum. | Pause the machine and redistribute laundry manually. |
| | There is very little laundry in the drum. | Load more laundry. |
| | Unstable floors eg. wooden floors. | Refer to relevant paragraph in "Positioning" section. |
| Cycle time longer than displayed: | Detergent over dose. | Reduce the detergent quantity or use another one. (Refer page 27 "Detergents Type And Quantity Of Detergent"). |
| | Machine unbalance. | Redistribute laundry manually in the drum and start the spin phase again. |
| The cycle is shorter than the time displayed. | The appliance calculated a new time according to the laundry load. | |
| Spinning starts late or machine does not spin: | The electronic unbalance detection device has cut in because the laundry is not evenly distributed in the drum. The laundry is redistributed by reverse rotation of the drum. | Pause the machine and redistribute laundry manually. |
| | This may happen several times before the unbalance disappears and normal spinning can resume. If, after 10 minutes, the laundry is still not evenly distributed in the drum, the machine will not spin. In this case, redistribute the load manually and select the spin program. | |
| Machine makes an unusual noise: | Machine not installed properly. | Make sure the levelling of the appliance is correct. Refer to "Installation". |
| | Transit bolts or packaging not removed. | Make sure that the packaging and/or the transit bolts are removed. Refer to "Unpacking". |
| | The load may be too small. | Add more laundry in the drum. |
| No water is visible in the drum: | Machines based on modern technology operate very economically using very little water without affecting performance. | |

| Malfunction | Possible cause | Solution |
|--|--|---|
| Machine does not dry or does not dry properly: | The "Time Dry" or the "Dryness Level" degree has not been selected. | Select the drying time or the dryness level degree. |
| | The water tap is not turned on. (Error code: E 10) | Open the water tap. |
| | The drain filter is clogged. (Error code: E 20) | Clean the drain filter. |
| | The machine is overloaded. | Reduce the laundry load in the drum. |
| | The selected drying program, time or dryness level was not suitable for the laundry. | Select the suitable drying program, time or dryness level for the laundry. |
| Display time is frozen at the end of drying cycle for more than 30 minutes: | Machine is optimizing the drying cycle according to the laundry type and load size. It will vary for each kind of fabric as the water absorption is different. | This is a normal behavior of the machine and not a cause for concern as it does not compromise its performance. |
| Remote function does not work: | Registration Data lost or damaged. (Error Code: E R0) | Restart machine by turn Off and turn On again. If problem not solved, please contact Service Centre. |

i NOTE

If you are unable to identify or solve the problem, contact our service centre. Before calling service centre, make a note of the model, serial number and purchase date of your machine: the Service Centre will require this information.

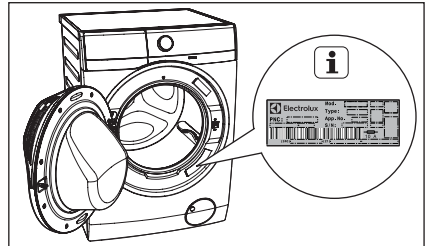

12.2 Emergency Door Opening

In case of power failure or appliance failure, the appliance door remains locked. The wash program continues when power is restored. If the door remains locked in case of failure, it is possible to open it using the emergency unlock feature.

Before opening the door:



WARNING!

Make sure that the water temperature and the laundry are not hot. Wait until they cool down if necessary.

Make sure that the water level inside the drum is not too high. If necessary, perform an Emergency Drain (see page 34).

Make sure that the drum is not rotating. Wait until the drum stops rotating if necessary.

To open the door proceed as follows:

1. Press the On/Off button to switch the appliance off.
2. Disconnect the mains plug from the mains socket.
3. Open the filter cover.
4. Without touching the door. Insert a small flathead screw driver into the slot on emergency unlock strap (red strap) and pull down twice then pull the door open.
Repeat if unsuccessful.

Note: Do not pull down emergency strap too hard.

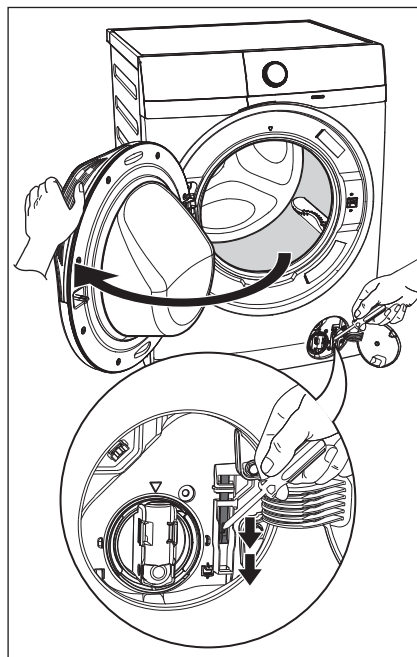

5. Take out the laundry.
6. Close the filter flap.

13. TECHNICAL DATA

| | | | |
|--|---|--------------------------|---------------|
| Dimensions (Height / Width / Depth) | 85 X 60 X 65.9 cm | | |
| Power supply (Voltage / Frequency) | 220-240 V~ / 50 Hz | | |
| Total power absorbed | Wash: 2100 W / Dry: 1500 W | | |
| Water supply pressure (Maximum / Minimum) | 0.8 MPa / 0.05 MPa | | |
| Maximum dry clothes capacity | | Washing | Drying |
| | Cottons | Max.¹⁾ | 7 kg |
| | Mixed | 4 kg | 3 kg |
| | Bedding | 3 kg | – |
| | Baby Care | 4 kg | – |
| | Energy Saver | Max. | 7 kg |
| | Vapour Refresh | 1.5 kg | – |
| | App Program | – | – |
| | Spin | Max. | 7 kg |
| | Rinse + Spin | Max. | 7 kg |
| | Quick 15 | 1.5 kg | – |
| | Daily 60 | 5.5 kg | 4 kg |
| | Wool  | 2 kg | 1 kg |
| | Delicates | 4 kg | – |
| WashDry 60 | 1 kg | 1 kg | |
| Favourite ☆ | – | – | |
| Spin speed (Maximum / Minimum) | 1400 rpm / 400 rpm | | |

1) Maximum capacity depended on model:

Model EWW1141AEWA : 11 kg

Model EWW1042AEWA : 10 kg

14. INSTALLATION

14.1 Unpacking



CAUTION!

All transit bolts and packing must be removed before using the appliance.

You are advised to keep all transit devices so that they can be refitted if the machine ever has to be transported again.

1. Use gloves. Cut and remove four cut out straps as shown.

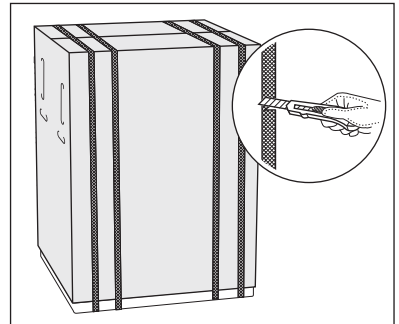

2. Remove the carton box. Remove the polystyrene packaging materials. Remove the plastic bag which cover the machine.

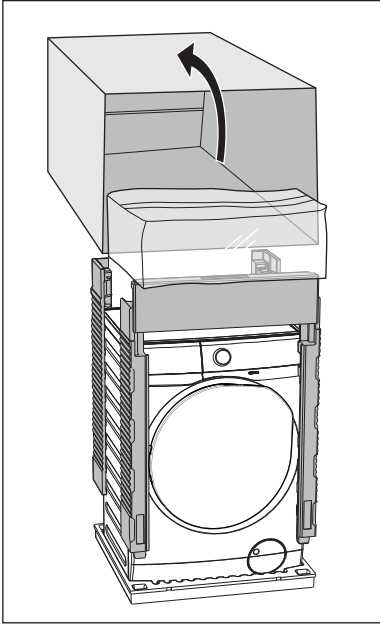

3. Open the door. Remove the polystyrene piece from the door seal and all the items from the drum.

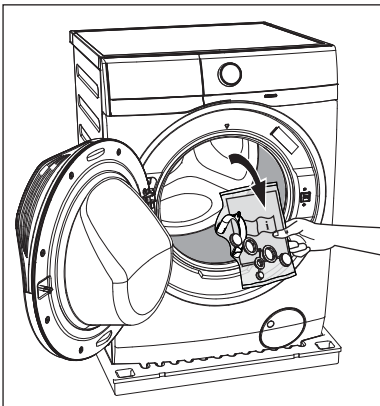

4. Put one of the polystyrene packaging elements on the floor behind the appliance. Carefully put down the appliance with the rear side on it. Make sure not to damage the hoses.

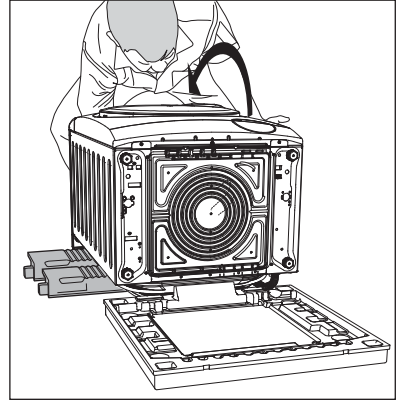

5. Remove the polystyrene base.

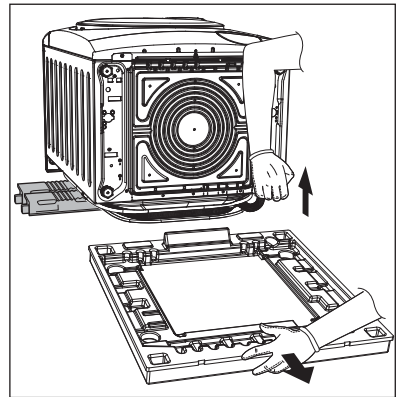

6. Pull up the appliance in vertical position.
7. Remove the power supply cable and the drain and inlet hoses from the hose holders (A) on the rear of the appliance.

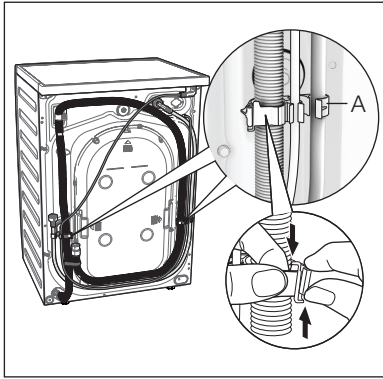

- 8. Remove the three transit bolts.
- 9. Pull out the plastic spacers.

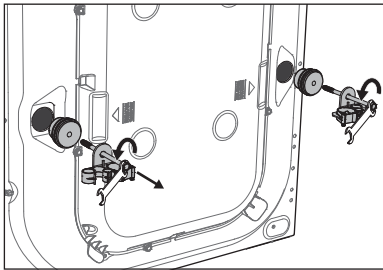
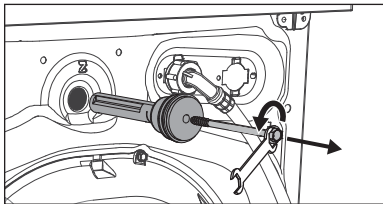

- 10. Put the plastic caps in the holes (X3). You can find these caps in the user manual bag.

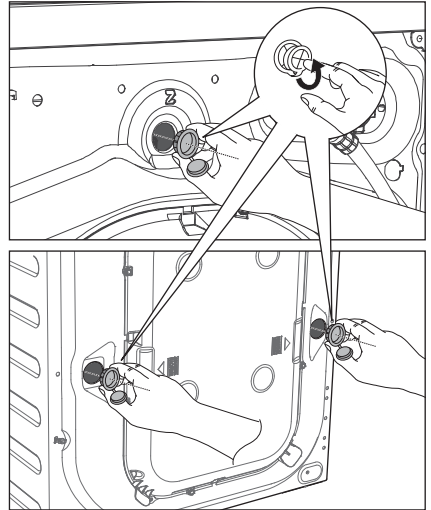
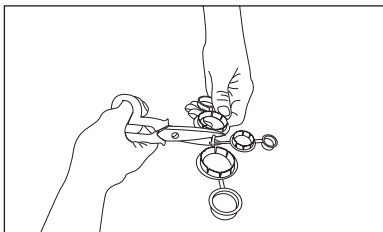

14.2 Positioning

It is important that your Washer-Dryer stands firm and leveled on the floor to ensure correct operation. The appliance must not be installed behind a lockable door, a sliding door or a door with a hinge on the opposite side to avoid restricting the Washer-Dryer door.

Use a spirit level on the top and side of the Washer-Dryer to check the levels.

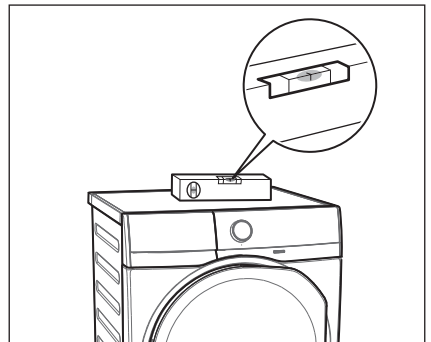

If you do not have a spirit level, as a guide use the edge of a door frame, cupboard or bench to check that the Washer-Dryer is leveled.

Loosen or tighten the feet to adjust the level. A correct adjustment of the appliance level prevents vibration, noise and the movement of the appliance when in operation.

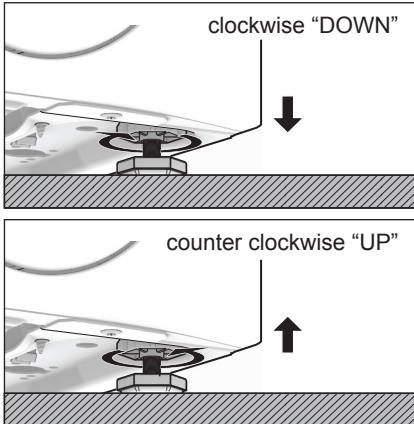

When the Washer-Dryer is levelled, try to rock it from corner to corner. If it does rock, adjust the legs again until it is levelled and does not rock.

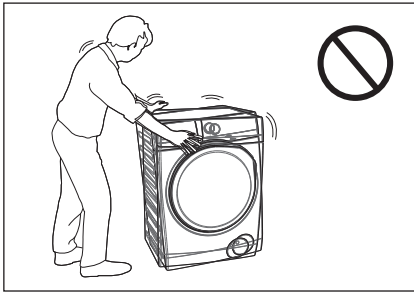

Never place cardboard, wood or similar materials under the machine to compensate for any unevenness in the floor. Install the machine on a flat hard floor. Make sure that air circulation around the machine is not impeded by carpets, rugs etc.

Check that the machine does not touch the wall or cupboard units.

14.3 Water Inlet

Connect the water inlet hose to a tap with 3/4" BSP thread.

Use the hose supplied with the Washer-Dryer. **DO NOT USE OLD HOSES.**

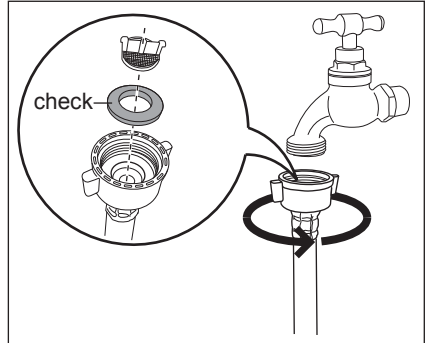

The inlet hose must not be lengthened. If it is too short and you do not wish to move the tap, you will have to purchase a new, longer hose specially designed for this type of use.

Loosen the ring nut to angle the hose to the left or right depending on the position of your water tap. Do not place the inlet hose downwards. After positioning the inlet hose, be sure to tighten the ring nut again to prevent leaks.

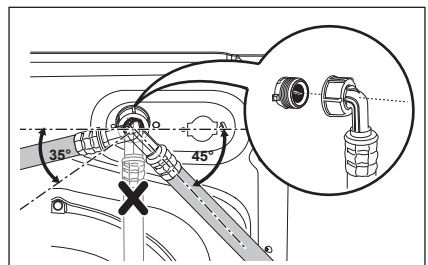

14.4 Water Drainage

The end of the drain hose can be positioned in three ways:

- **Hooked over the edge of a sink**, using the plastic hose guide supplied with the machine.

Fitting Hose Guide

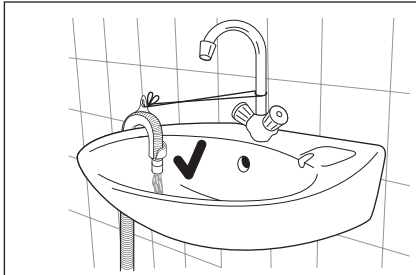
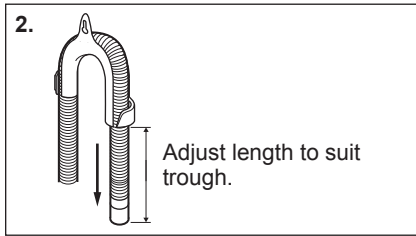
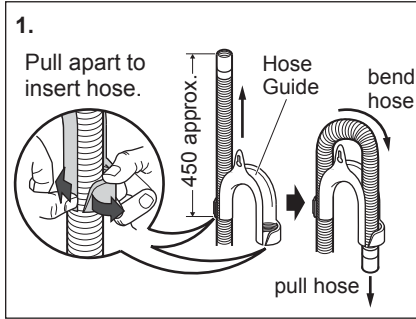

In this case, make sure the end cannot come unhooked when the machine will be emptied. This could be done by tying it to the tap with a piece of string or attaching it to the wall.

• **In a sink, drain pipe branch.**

This branch must be above the trap so that the bend is at least 60 cm above the ground.

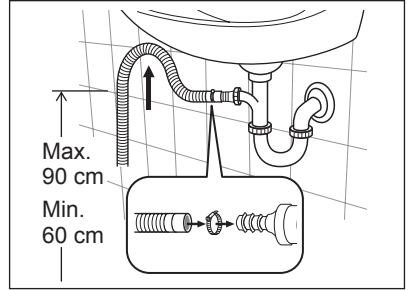

Push the drain hose onto the spigot and secure with a clamp, ensure a loop is formed in the drain hose to prevent waste from the sink entering the appliance.

• **Directly into a drain pipe,** at a height of not less than 60 cm and not more than 90 cm.

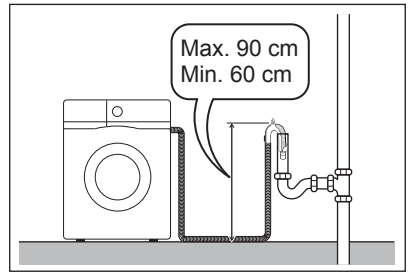

The end of the drain hose must always be ventilated, i.e. the inside diameter of the drain pipe must be larger than the outside diameter of the drain hose.

The drain hose must not be twisted or curled. Run it along the floor; only the part near the drainage point must be raised.

For the correct functioning of the machine, the drain hose must remain hooked on the proper support piece situated on the top part of back side of the appliance.

14.5 Electrical Connection

This machine is designed to operate on a 220-240 V, single-phase, 50 Hz supply.

“An incorrect power supply may void your warranty.”

Check that your domestic electrical installation can take the maximum load required (refer page 40), also taking into account any other appliances in use.



CAUTION!

Connect the machine to an earthed socket outlet.



The manufacturer declines any responsibility for damage or injury through failure to comply with the above safety precaution.



Should the appliance power supply cable need to be replaced, this shall be carried out by our Service Centre.

When the appliance is installed, the power supply cable must be easily accessible.

15. ENVIRONMENT CONCERNS

15.1 Packaging Materials



The materials marked with the symbol  are recyclable.

>PE<=polyethylene

>PS<=polystyrene

>PP<=polypropylene

This means that they can be recycled by disposing them properly in appropriate collection containers.

15.2 Old Machine

Use authorized disposal sites for your old appliance. Help to keep your country tidy!

The symbol  on the product or on its packaging indicates that this product may not be treated as household waste.

Instead it shall be handed over to the applicable collection point for the recycling of electrical and electronic equipment. By ensuring this product is disposed of correctly, you will help prevent potential negative consequences for the environment and human health, which could otherwise be caused by inappropriate waste handling of this product.

For more detailed information about recycling of this product, please contact your local city office, your household waste disposal service or the shop where you purchased the product.

15.3 Ecological Hints

To save water, energy and to help protect the environment, we recommend that you follow these tips:

- Normally soiled laundry may be washed without prewashing in order to save detergent, water and time (the environment is protected too!).
- The machine works more economically if it is fully loaded.
- With adequate pre-treatment, stains and limited soiling can be removed; the laundry can then be washed at a lower temperature.
- Measure out detergent according to the water hardness, the degree of soiling and the quantity of laundry being washed.

16. WI-FI CONNECTIVITY SETUP

THIẾT LẬP KẾT NỐI WI-FI

English

This chapter describes how to connect the smart appliance to the Wi-Fi network and to link it to a mobile devices.

By this functionality you can monitor and control your laundry appliance from your mobile devices.

To connect the appliance to enjoy the full range of features and services you need:

- Wireless network at home with internet connection enabled.
- Mobile device connected to wireless network.

| | |
|------------------|---|
| Frequency | 2.4 GHz according to local country regulation |
| Protocol | IEEE 802.11b/g/n |
| Max Power | According to local country regulation |

16.1 Installing and configuring “Electrolux Life” App.

Make sure that your smart device is connected to the 2.4 GHz wireless network.

1. Go to the App Store/Play Store on your smart device.



2. Download and install App “Electrolux Life”. 

* Minimum requirements: iPhone6/iOS 9.3/Android 5.1 and above. You will need to install the Electrolux Life App, create an Electrolux account and accept the Terms and Conditions and Electrolux’s Privacy Policy in the App to use the connected features of the laundry appliance. Internet and Wi-Fi connections are required to use the full features of the App and the laundry appliance. Minimum requirements, Apps and services are subject to change without notice.

3. Create an Electrolux account. You can only create one Electrolux account per product. This account can be shared across multiple devices.
4. Setting up your Washer-Dryer. Make sure your machine is plugged in and operating normally, stand near it with your smart device.

TIẾNG VIỆT

Chương này mô tả cách kết nối máy giặt/sấy thông minh với mạng Wi-Fi và liên kết thiết bị đó với thiết bị di động.

Với chức năng này, bạn có thể nhận được các thông báo, theo dõi và điều khiển máy giặt/sấy từ thiết bị di động.

Để kết nối và thử trải nghiệm toàn bộ tính năng và dịch vụ của máy bạn cần:

- Mạng không dây tại nhà có kết nối internet.
- Thiết bị di động được kết nối với mạng không dây.

| | |
|-------------------------|--------------------------------------|
| Tần số | 2,4 GHz theo quy định của địa phương |
| Giao thức | IEEE 802.11b/g/n |
| Công suất tối đa | Theo quy định của địa phương |

16.1 Cài đặt và thiết lập cấu hình cho “Electrolux Life” App.

Đảm bảo thiết bị thông minh kết nối với mạng không dây 2.4 GHz.

1. Đi tới App Store/Cửa hàng Play store trên thiết bị thông minh.



2. Tải xuống và cài đặt Ứng dụng “Electrolux Life”. 

* Yêu cầu tối thiểu: iPhone6/iOS 9.3/Android 5.1 trở lên. Bạn cần cài đặt Ứng dụng Electrolux Life, tạo tài khoản Electrolux, chấp nhận Điều khoản và điều kiện cũng như Chính sách bảo mật của Electrolux trong Ứng dụng để sử dụng các tính năng được kết nối của máy giặt/sấy. Bạn cũng cần có kết nối Internet và Wi-Fi để sử dụng được toàn bộ tính năng của Ứng dụng và máy giặt/sấy. Các yêu cầu tối thiểu, Ứng dụng và dịch vụ có thể thay đổi mà không cần thông báo.

3. Tạo tài khoản Electrolux. Với mỗi sản phẩm, bạn chỉ có thể tạo một tài khoản Electrolux. Tài khoản này có thể sử dụng trên nhiều thiết bị.
4. Thiết lập máy giặt/sấy. Đảm bảo máy giặt/sấy đã được cắm điện và đang hoạt động bình thường, hãy cắm thiết bị thông minh đứng gần máy.

English



Tap on "Appliances" at the bottom of the home screen.

Tap on "Add Appliance" and follow the prompts on screen.

* Setup will take several minutes depending on your network speed.

- Turning on your Washer-Dryer Wi-Fi. Initially your machine creates its own Wi-Fi network to assist in setting up. After setup this network disappears and your machine will connect to your home Wi-Fi network.

Press and hold  Remote touch button for 3 seconds.

The text  pop up for about 5 seconds and the icon  starts flashing and wireless module begins starting up. It may take about 45 seconds before it is ready. When the wireless module is ready, the text  (**Access Point**) is on to inform you, that the access point will be open for about 3 minute.

The Washer-Dryer is now creating a temporary network for the next step.

- Connect your Washer-Dryer:

iOS

Tap the home button to exit the app.

Go to "Settings" on your phone and select "Wi-Fi".

Select your Washer-Dryer's Wi-Fi network. It is the one that begins with "AJ-" – (it may take a few moments to appear).

Tap the home button to exit your phone settings and then return to the Electrolux Life App.

Wait for confirmation of connection which may take up to a minute before proceeding to the next step.

Android

For Android devices, select your Washer-Dryer's Wi-Fi network from the drop-down box.

TIẾNG VIỆT



Nhấn vào tab "Thiết bị" ở cuối màn hình chính trong Ứng dụng Electrolux life.

Nhấn vào "THÊM THIẾT BỊ" và làm theo hướng dẫn trên màn hình.

*Thời gian thiết lập sẽ kéo dài vài phút tùy theo tốc độ mạng của bạn.

- Bật Wi-Fi trên máy giặt/sấy. Đầu tiên, máy giặt/sấy sẽ tự tạo Wi-Fi tạm thời để hỗ trợ thiết lập. Lưu ý: sau khi thiết lập xong, mạng Wi-Fi tạm thời - bắt đầu bằng chữ "AJ-" sẽ biến mất và máy giặt/sấy sẽ kết nối với mạng Wi-Fi nhà bạn.

Nhấn và giữ nút Remote - Từ xa  trong 3 giây.

Chữ  hiển thị trong 5 giây và biểu tượng  bắt đầu nhấp nháy, đồng thời mô-đun phát wifi bắt đầu khởi động. Có thể mất khoảng 45 giây mô-đun này mới sẵn sàng. Khi mô-đun phát wifi sẵn sàng, chữ  (Điểm truy cập) hiển thị để thông báo điểm truy cập sẽ mở trong khoảng 3 phút.

Bây giờ, máy đang tạo kết nối tạm thời cho bước tiếp theo.

- Kết nối máy:

iOS

Nhấn vào nút home (màn hình chính) để thoát khỏi ứng dụng. Đi tới "Settings" (Cài đặt) trên điện thoại của bạn và chọn "Wi-Fi".

Chọn mạng Wi-Fi của máy. Tên mạng này bắt đầu bằng chữ "AJ-" – (có thể mất vài giây mới xuất hiện).

Nhấn vào nút home (màn hình chính) để thoát khỏi cài đặt điện thoại rồi quay lại Ứng dụng Electrolux Life.

Đợi xác nhận kết nối, quá trình này có thể mất tới một phút rồi chuyển sang bước tiếp theo.

Android



Trên thiết bị Android, chọn mạng Wi-Fi từ menu kéo xuống.



English

7. Connect your Washer-Dryer to your home Wi-Fi.

You'll need to select your Wi-Fi network name and input your password.

-  For iOS devices, you will then be prompted to go to "SETTINGS" on your phone and select your Home Wi-Fi, then return to the Electrolux Life App.

If the connectivity is configured,  (Access Point) symbol is off and the icon  will stop blinking and lit steadily to confirm that the configuration was successful.

-  Every time you switch the Washer-Dryer on, the machine takes 45 seconds to connect to the network automatically. When the indicator  stops blinking the connection is ready.

Connection success!

Please proceed to the next screen to register the Washer-Dryer.

8. Product registration; Simply add your Washer-Dryer's name and the purchase date.

Congratulations!



Now you're all set up. You can start exploring the Electrolux Life App.



TIẾNG VIỆT

7. Kết nối máy với mạng Wi-Fi nhà bạn.

Bạn cần chọn tên mạng Wi-Fi và nhập mật khẩu.

-  Với thiết bị iOS, sau đó, bạn sẽ được thông báo tới "SETTINGS" (Cài đặt) trên điện thoại và chọn mạng Wi-Fi nhà mình rồi quay lại Ứng dụng Electrolux Life.

Nếu kết nối đã được thiết lập, biểu tượng  (Điểm truy cập) sẽ tắt còn biểu tượng  sẽ dừng nhấp nháy và sáng liên tục để xác nhận đã cấu hình thành công.

-  Mỗi khi bạn bật máy, máy sẽ mất khoảng 45 giây để tự động kết nối với mạng. Khi đèn báo  dừng nhấp nháy thì kết nối đã sẵn sàng.

Kết nối thành công!

Vui lòng chuyển sang màn hình tiếp theo để đăng ký thiết bị.





8. Đăng ký sản phẩm: Chỉ cần thêm tên máy giặt/sấy và ngày mua.

Xin chúc mừng!

Bây giờ, bạn đã thiết lập xong hoàn toàn. Bạn có thể bắt đầu khám phá Ứng dụng Electrolux Life.

English

To switch the wireless connection off,

Press and hold  Remote touch button for 3 seconds until the first acoustic signal:    appears on the display.

 If you switch the machine off and on again, the wireless connection is automatically off.

To remove the wireless credentials,



Press and hold  Remote touch button for 10 seconds until the second acoustic signal: — — — appears on the display.

16.2  Remote Start

When the App is installed and the wireless connection is complete, you can start and stop a program remotely by activate remote start.

 The Remote Control activates automatically when you press the **Start/Pause** button to start the program, but it is also possible to start a program.

Activate Remote Start

1. Press the  **Remote** button and the indicator  appears on the display.
2. Press the **Start/Pause** button to activate the Remote Start.

Now it is possible to start the program remotely.

Deactivate Remote Start





Press the  **Remote** touch button.

The  icon is off and the remote start is deactivated.

 **If the door is unlock**, the Remote Start is deactivated.

TIẾNG VIỆT

Đề tắt kết nối không dây,

Hãy nhấn và giữ nút Remote - Từ xa  trong 3 giây tới khi tín hiệu âm thanh đầu tiên:    xuất hiện trên màn hình.

 Nếu bạn tắt và bật lại máy, kết nối không dây sẽ tự động tắt.

Đề xóa thông tin đăng nhập không dây,



Hãy nhấn và giữ nút Remote - Từ xa  trong 10 giây tới khi tín hiệu âm thanh thứ hai: — — — xuất hiện trên màn hình.

16.2  Điều khiển từ xa

Khi đã cài đặt Ứng dụng và hoàn thành kết nối không dây, bạn có thể khởi động và dừng chương trình từ xa bằng cách kích hoạt chức năng điều khiển từ xa.

 Điều khiển từ xa tự động kích hoạt khi nhấn nút Start/Pause (Khởi động/Tạm dừng) để khởi động chương trình nhưng cũng có thể dùng để bắt đầu một chương trình giặt/sấy.

Kích hoạt chức năng điều khiển từ xa

1. Nhấn nút Từ xa  và đèn báo  xuất hiện trên màn hình.
2. Nhấn nút Start/Pause (Khởi động/Tạm dừng) để kích hoạt chức năng Điều khiển từ xa.

Bây giờ, bạn có thể điều khiển từ xa.

Tắt chức năng điều khiển từ xa

Nhấn nút Remote - Từ xa .

Biểu tượng  tắt và chức năng điều khiển từ xa cũng tắt.

 **Nếu cửa bị mở khóa**, chức năng Khởi động từ xa sẽ tắt.

www.electrolux.vn



G0021602-002-A12317383