

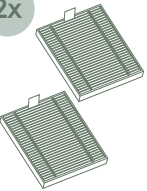



 electrolux.com/shop

<p>2x</p>  <p>Filter Kit Ref: EFR4 PNC: 900 923 683</p>	<p>2x</p>  <p>Mopping Pads Ref: EMR2 PNC: 900 923 686</p>	<p>2x</p>  <p>2x</p>  <p>2x</p>  <p>1x</p>  <p>Robotic peak performance kit Ref: ERK6 PNC: 900 923 687</p>
---	---	---

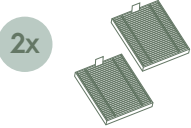
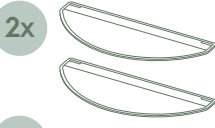

The software in the robot is partly based on free and open source software. To access the source code of these components and to see the full copyright information and applicable license terms, please visit:
www.electrolux.com/rvc-supplementary

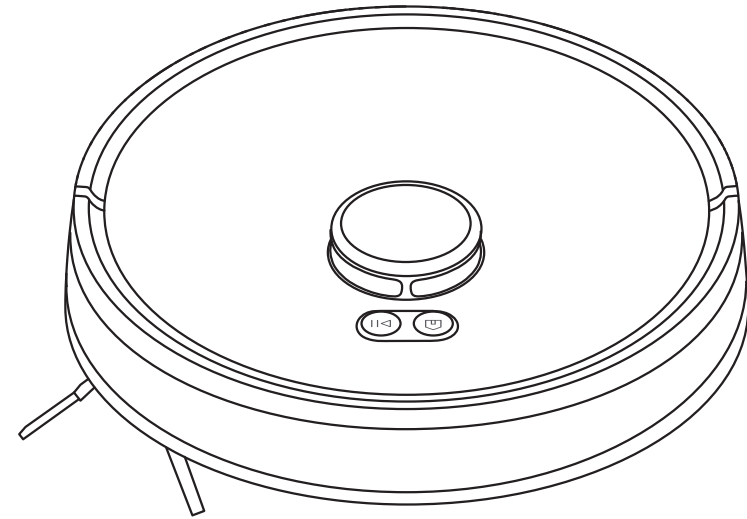

EFR71222



 **USE ONLY :**

 <p>DS-CB71</p>	 <p>KA1201A-2000600EU or KA1201A-2000600BS</p>
--	---

