

1

* Certain models only | 仅限特定型号 | Model tertentu saja | 특정 브러시는 어댑터 장착 필요 | เฉพาะบางรุ่นเท่านั้น
 僅適用特定型號 | Chỉ có ở một số model

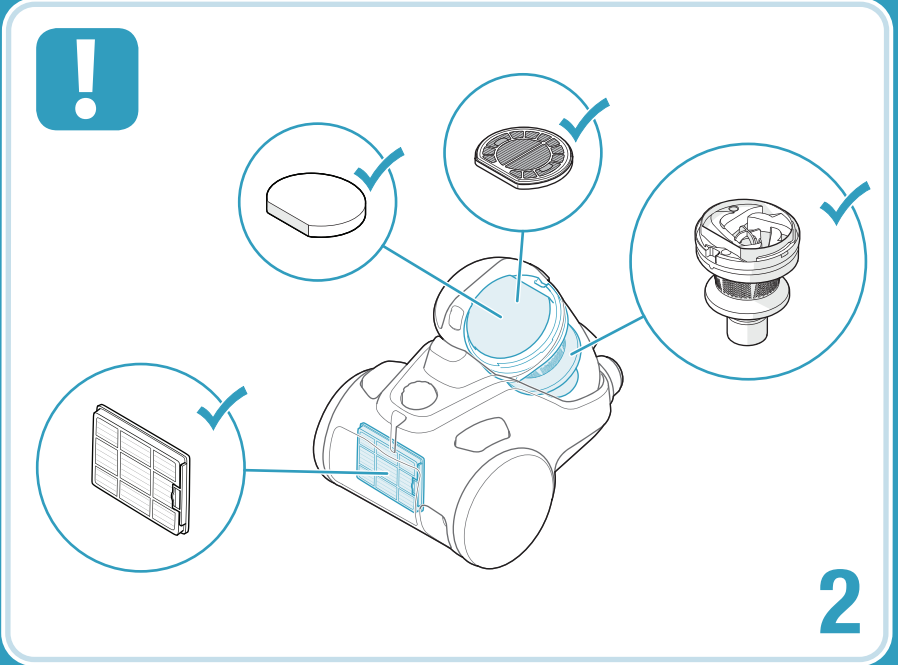

2

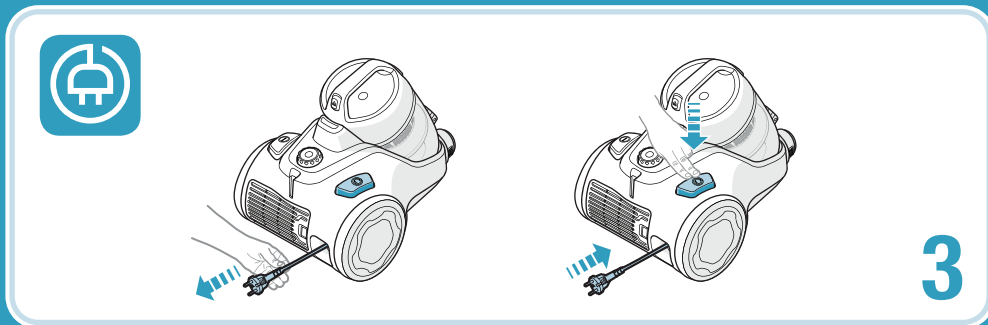

3

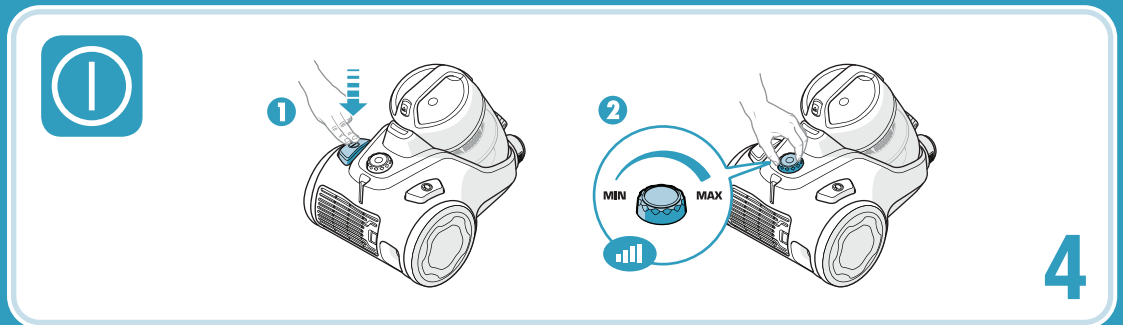

4

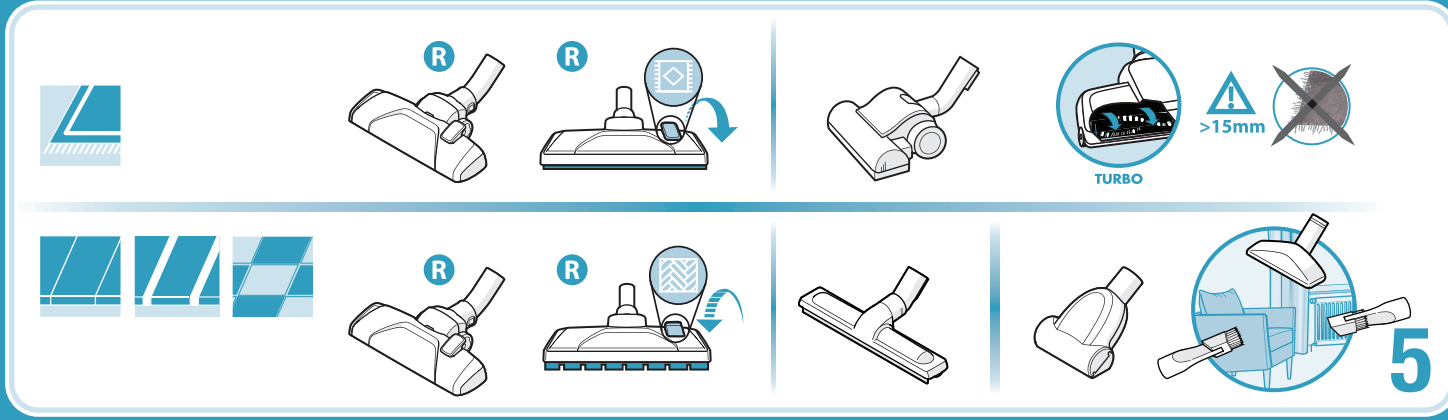

5

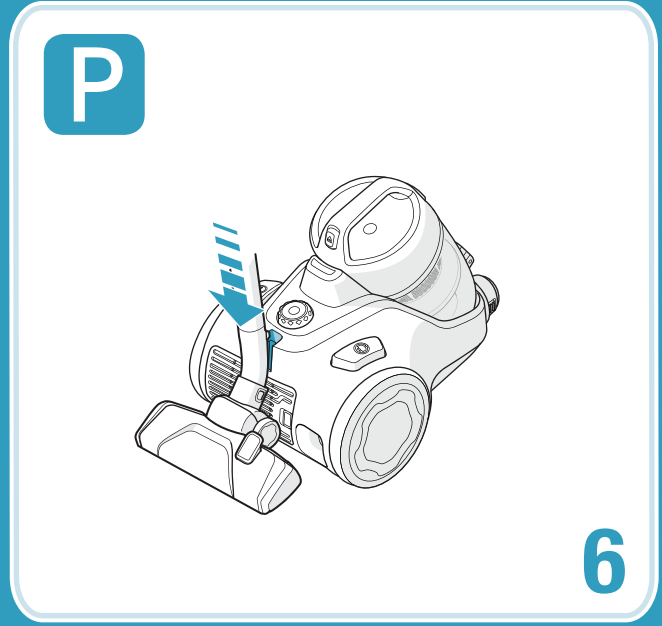

6

R Recommended nozzle | 推荐的吸嘴 | Nosel yang dianjurkan | 권장 노즐 | ท่อที่แนะนำ | 推薦的吸嘴 | Đầu hút được khuyên dùng

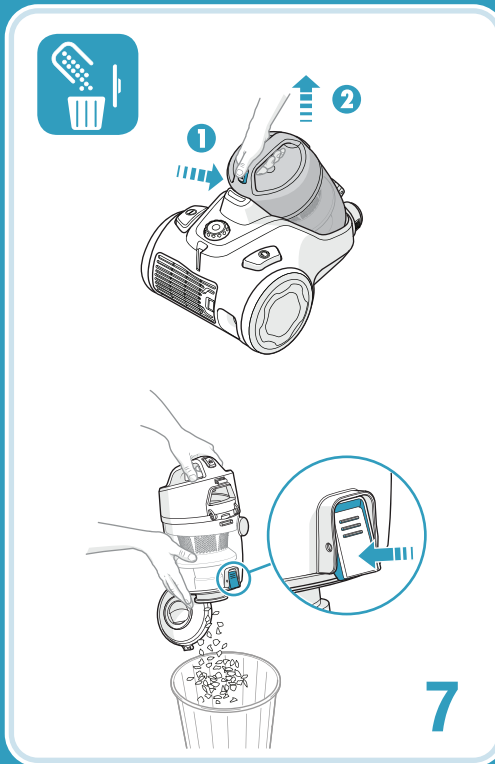

7

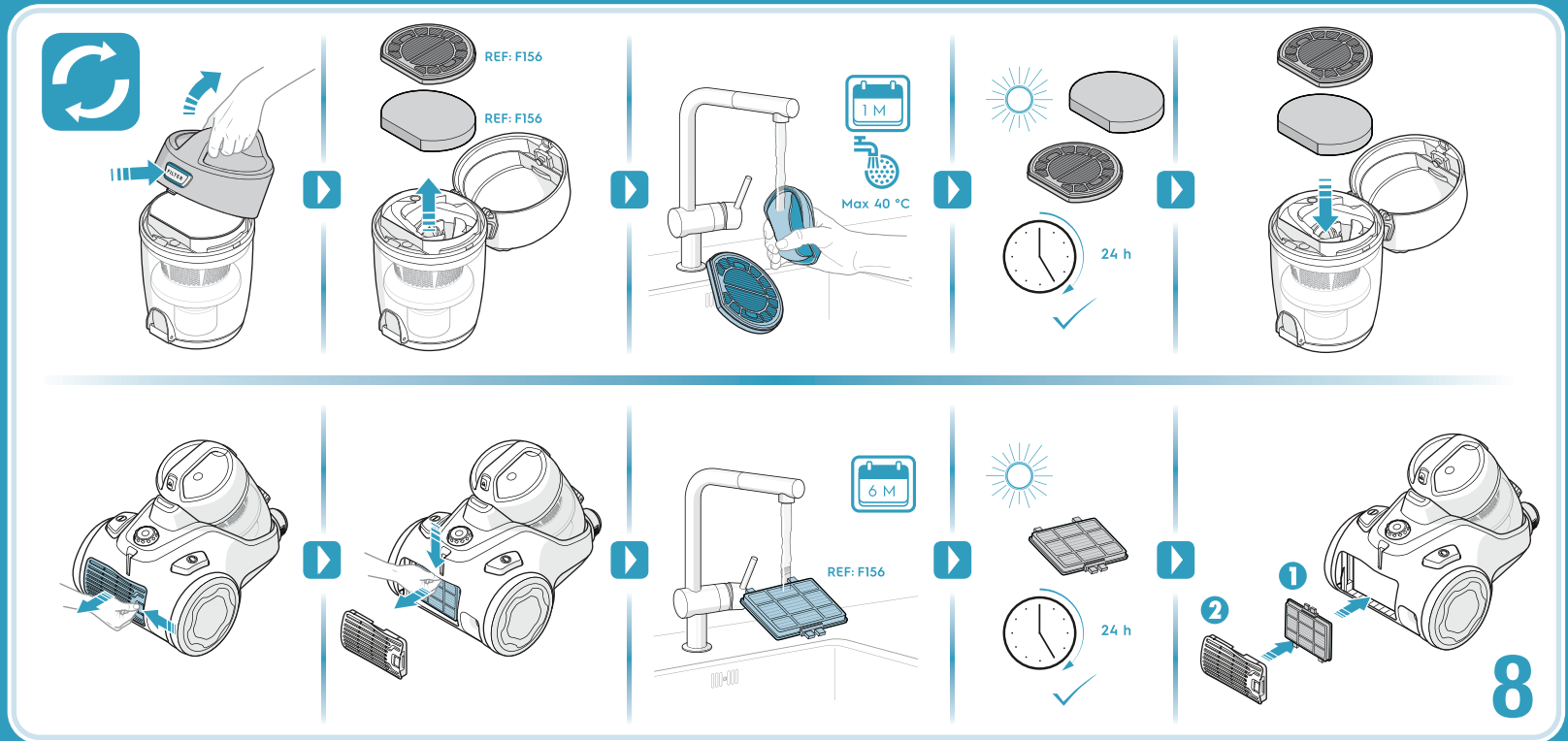

8

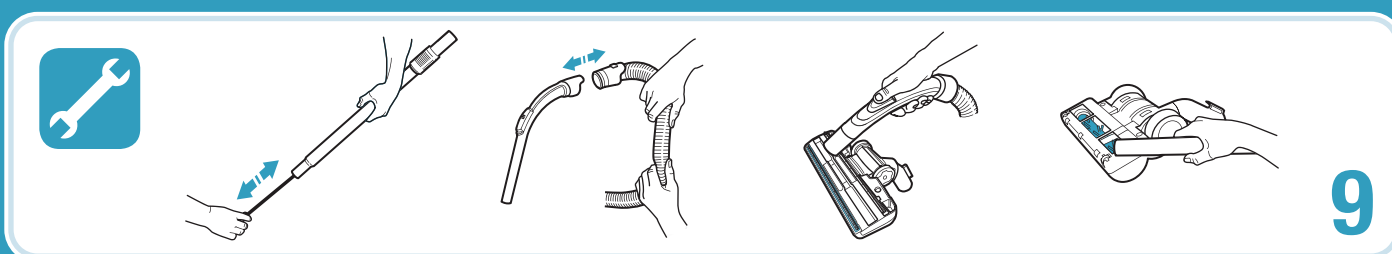

9

! www.electrolux.com/shop
www.electroluxshop.co.kr
<https://shop.electrolux.com.au/>
 (for selected countries only)

Safety requirements and warning

This appliance can be used by children aged from 8 years and above and persons with reduced physical, sensory or mental capabilities or lack of experience and knowledge if they have been given supervision or instruction concerning use of the appliance in a safe way and understand the hazards involved.

WARNING: Turbo nozzles* have a rotating brush in which parts may become entrapped. Please use them with caution and only on intended surfaces. Please turn the vacuum cleaner off before removing entrapped parts or cleaning the brush. *Certain models only.

Children should be supervised to ensure that they do not play with the appliance.

Cleaning and maintenance shall not be made by children without supervision.

Always disconnect the plug from the mains before cleaning or maintaining the appliance.

Never use the vacuum cleaner without its filters.

Caution

This appliance contains electrical connections.

- Never vacuum any liquid.
- Do not immerse in any liquid for cleaning.
- The hose should be checked regularly and must not be used if damaged.

The above can cause serious damage to the motor, which is not covered by the warranty.

This vacuum cleaner is for domestic use only.

Never use vacuum cleaner

- Close to flammable gases, etc.
- On sharp objects.
- On hot or cold cinders, lit cigarette butts, etc.
- On fine dust, for instance plaster, concrete, flour.

Power cord precautions

- Regularly check that the plug and cord are not damaged. Never use the vacuum cleaner if the cord is damaged.
- If the cord is damaged, it must be replaced only by an authorized Electrolux service centre in order to avoid a hazard. Damage to the vacuum cleaner's cord is not covered by the warranty.
- Never pull or lift the vacuum cleaner by the cord.

All servicing and repairs must be performed by an authorized Electrolux service centre.

Store the vacuum cleaner in a dry place.

Consumer information

Electrolux declines all responsibility for all damages arising from any improper use of the appliance or in cases of tampering with the appliance. For more details of warranty and consumers' contacts see the Warranty Booklet in the packaging. If you have any comments on the cleaner or the Operating Instructions manual please e-mail us at floorcare@electrolux.com.

Sustainability policy

This product is designed with the environment in mind. All plastic parts are marked for recycling purposes.

For details see our website: www.electrolux.com.

The packaging material is chosen to be environmentally friendly and can be recycled.

Recycle the materials with the symbol . Put the packaging in applicable containers to recycle it. Help protect the environment and human health and to recycle waste of electrical and electronic appliances.

Do not dispose appliances marked with the symbol  with the household waste. Return the product to your local recycling facility or contact your municipal office.

The declared values on the energy label are measured according to the required measurement methods (EN60312-1).

Problem	Solution
The vacuum cleaner does not start	<ul style="list-style-type: none"> • Check that the cable is connected to the mains. • Check that the plug and cable are not damaged. • Check for a blown fuse.
The cleaner shuts	The cleaner might be overheated: disconnect it from the mains; check if the nozzle, tube, hose or filters are blocked. Let the cleaner cool down for 30 minutes before plugging it in again. If the cleaner still does not work, contact and authorized Electrolux service centre.
Reduced suction capacity	<ul style="list-style-type: none"> • Check if the dust container is full or blocked. • Check if the nozzle, tube hose or filters are blocked. • Check if the dust container and filters are in place. Clean or replace the filter. If the hose is damaged it will be necessary to replace it.
Clearing the hose	Clear the hose by "squeezing" it. However, be careful in case the obstruction has been caused by glass or needles caught inside the hose. Note: The warranty does not cover any damage to the hose caused by cleaning it.
The vacuum cleaner is overheated	<ul style="list-style-type: none"> • Check if the dust container is full or blocked. Empty the dust container. • Clean or replace the filter.
Water has been sucked into the vacuum cleaner	It will be necessary to replace the motor at an authorized Electrolux service centre. Damage to the motor caused by the penetration of water is not covered by the warranty
For any further problems, contact an authorized Electrolux service centre.	

安全要求和警告

本机不可由肢体伤残、感觉或精神障碍以及缺乏相关经验和知识的人员（包括儿童）使用，除非有负责其安全的人员对其进行看管或指导。

警告： 涡轮吸嘴*带有可能导致部件被卡住的旋转刷头。在使用时请务必谨慎，并且仅在预期表面上使用。在取出被卡住的部件或清洁刷头之前，请首先关闭吸尘器的电源。*仅限特定型号。

应对儿童加以看管，确保他们不将本器具当作玩具。

清洁和维护不应由儿童在无人监督的情况下完成。

清洁或维护本器具时，务必断开插头与主电源的连接。

切勿在未安装滤网的情况下使用吸尘器。

小心

本器具内含电气连接。

- 切勿吸取任何液体。
- 切勿将其浸没在任何液体中进行清洁。
- 应定期检查软管，如有损坏，不得使用。

违反上述要求可能导致电机严重损伤，此后果不在保修范围之内。

本吸尘器仅供家庭使用。

切勿在以下情况下使用吸尘器

- 靠近易燃气体等时。
- 存在锋利物体时。
- 存在热或冷的炭渣、未熄灭的烟蒂等物品时。
- 存在细末粉尘（例如石膏粉、水泥、面粉）时。

电源线防范措施

- 定期检查插头和电源线，确保它们未损坏。如果电源线损坏，切勿使用吸尘器。
- 如果电源线受损，为了避免造成危险，将只能由获得授权的伊莱克斯服务中心进行更换。吸尘器电源线受损不在保修范围之内。
- 切勿通过电源线拉扯或提起吸尘器。

所有服务或维修都必须由获得授权的伊莱克斯服务中心进行。

请将吸尘器存放在干燥的位置。

消费者信息

对于因不当使用或擅自改动本器具而引起的任何损害，伊莱克斯不承担任何责任。有关保修和消费者联系方式的更多详细信息，请参见包装中的《保修手册》。如果您对吸尘器或操作说明手册有任何意见，请发送电邮至floorcare@electrolux.com。

可持续性政策

本产品在设计时融入了环保理念。所有塑料部件均进行了标识以便于回收。有关详情，请参见我们的网站：www.electrolux.com。

包装材料采用了环保材料，可回收利用。

回收带有♻️标志的材料。把包装材料放入适用的容器以循环利用。帮助保护环境和人类健康，促进电器及电子产品的废物利用。

请勿将带有🗑️标志的电器与生活垃圾一起处理。将产品退回到您当地的回收处，或联系您所在城市的办事处。能量标签上的声明值是根据规定的测量方法 (EN60312-1) 测量所得。

问题	解决方案
真空吸尘器不启动	<ul style="list-style-type: none"> • 检查电缆是否已连接至电源插座。 • 检查插头和电缆未破损。 • 检查保险丝是否熔断。
吸尘器停止运转	可能是吸尘器过热：将其与主电源断开；检查吸嘴、伸缩管、软管或滤网是否堵塞。吸尘器冷却 30 分钟后再接上电源。如果吸尘器仍无法使用，请联系获得授权的伊莱克斯服务中心。
吸力下降	<ul style="list-style-type: none"> • 检查集尘盒是否已满或堵塞。 • 检查吸嘴、伸缩管、软管或滤网是否堵塞。 • 检查集尘盒和滤网是否固定到位。清洁或更换滤网。如果软管损坏，则需要更换软管。
清理软管	用“推挤”的方式对软管进行清理。但是，如果阻塞是由软管内的玻璃或针状物体引起的，请务必多加小心。注意：对于因清洁软管而导致的任何损伤，均不在保修范围内。
真空吸尘器过热	<ul style="list-style-type: none"> • 检查集尘盒是否已满或堵塞。清空集尘盒。 • 清洁或更换滤网。
真空吸尘器进水	必须送至获得授权的伊莱克斯服务中心更换电机。因进水而导致的电机损坏，不在保修范围之内。
有关任何进一步的问题，请联系获得授权的伊莱克斯服务中心。	

产品	真空吸尘器
型号	EC31-4BB
功率	1600W
产地	苏州
产品标准	GB4706.1-2005, GB4706.7-2004, GB4343.1-2009, GB17625.1-2012

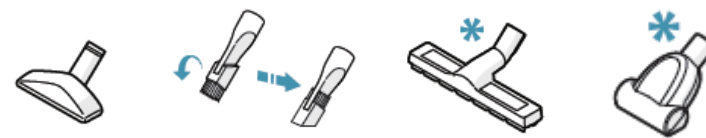
EC31-4BB 所含配件

*线条图仅用于说明，可能与实际产品有所不同。

Syarat dan peringatan demi keselamatan

Perangkat ini disarankan untuk digunakan oleh anak yang berusia diatas 8 tahun. Penggunaan oleh orang dengan kondisi fisik dan mental sudah berkurang, disarankan untuk diawasi atau dibekali dengan petunjuk penggunaan demi menjaga keamanan.

PERINGATAN: Nosel turbo* memiliki sikat berputar yang bisa saja terjatoh ke dalam. Gunakan dengan hati-hati dan hanya pada permukaan yang dimaksudkan. Matikan vacuum cleaner sebelum mengambil komponen yang terjatoh, atau sebelum membersihkan sikat. *Model tertentu saja.

Anak-anak harus diawasi untuk memastikan bahwa mereka tidak bermain-main dengan perangkat. Pembersihan dan perawatan oleh pengguna tidak boleh dilakukan oleh anak-anak tanpa pengawasan. Selalu cabut steker dari stopkontak sebelum membersihkan atau merawat perangkat. Jangan menggunakan vacuum cleaner tanpa filternya.

Perhatian

Perangkat ini menggunakan sambungan listrik.

- Jangan pernah menyedot cairan
- Jangan merendam perangkat di dalam air untuk dibersihkan.
- Selang harus diperiksa secara berkala dan tidak boleh digunakan jika rusak.

Tindakan di atas dapat menyebabkan kerusakan pada motor, yang tidak dikover garansi. Vacuum cleaner ini dirancang untuk penggunaan rumah tangga.

Jangan pernah menggunakan vacuum cleaner jika

- Di dekat gas yang mudah terbakar, dll.
- dipakai menyedot benda tajam.
- Menyedot abu panas atau dingin, puntung rokok, dll.
- Debu halus dari bahan plester/gypsum, tepung, semen, cor

Penggunaan Kabel listrik

- Periksa steker dan kabel dari kerusakan secara rutin. Jangan menggunakan vacuum cleaner jika kabelnya rusak.
- Jika rusak, kabel hanya boleh diganti di service center Electrolux yang berpengalaman untuk menghindari bahaya. Kerusakan pada kabel vacuum cleaner tidak dikover garansi.
- Jangan pernah menarik atau mengangkat vacuum cleaner dari kabelnya. Semua servis dan perbaikan hanya boleh dilakukan oleh service center Electrolux yang berpengalaman. Simpan vacuum cleaner di tempat yang kering.

Informasi Pelanggan

Electrolux tidak bertanggung jawab atas semua kerusakan yang muncul akibat penggunaan perangkat yang tidak semestinya, atau akibat mengutak-atik perangkat. Untuk rincian garansi dan kontak pelanggan lengkapnya, bacalah Buku Garansi dalam kemasan. Jika ada komentar tentang vacuum cleaner atau Petunjuk Pengoperasian, kirim kami email di floorcare@electrolux.com.

Kebijakan ramah lingkungan

Produk ini dirancang dengan memikirkan dampak terhadap lingkungan. Semua komponen plastik ditandai untuk tujuan daur ulang. Untuk rinciannya, buka situs kami: www.electrolux.com.

Bahan kemasan dipilih supaya ramah lingkungan dan dapat didaur ulang.

Lakukan daur ulang untuk bahan yang memiliki simbol . Letakkan kemasan di wadah yang berlaku untuk mendaur ulangnya. Bantu melindungi lingkungan dan kesehatan manusia dengan mendaur ulang perangkat listrik dan elektronik.

Jangan membuang perangkat yang ditandai simbol  bersama-sama dengan limbah rumah tangga.

Serahkan produk ke fasilitas daur ulang setempat, atau hubungi kantor provinsi Anda.

Nilai yang dideklarasikan pada label energi diukur sesuai dengan metode pengukuran yang diwajibkan. (EN60312-1).

Masalah	Solusi
Penyedot debu tidak bisa menyala	<ul style="list-style-type: none"> • Pastikan kabel sudah terhubung ke saluran listrik. • Pastikan steker dan kabel tidak rusak. • Pastikan tidak ada sekering yang putus.
Pembersih meletup	Pembersih mungkin mengalami panas berlebih: cabut steker dari saluran listrik; periksa apabila nosel, tabung, selang, atau filter tersumbat. Biarkan pembersih mendingin selama 30 menit sebelum menyambungkannya lagi ke saluran listrik. Jika pembersih tetap tidak menyala, hubungi <i>pusat layanan</i> resmi Electrolux.
Kapasitas isap berkurang	<ul style="list-style-type: none"> • Periksa apabila wadah debu penuh atau tersumbat. • Periksa apabila nosel, tabung, selang, atau filter tersumbat. • Periksa apabila wadah debu dan filter sudah terpasang. Bersihkan atau ganti filter. Penting untuk mengganti selang jika sudah rusak.
Membersihkan selang	Bersihkan selang dengan cara “meremas” selang. Namun, hati-hati jika penyumbatan disebabkan oleh kaca atau jarum yang tersangkut di dalamnya. Catatan: Garansi tidak mencakup segala kerusakan pada selang yang terjadi saat proses pembersihan.
Penyedot debu mengalami panas berlebih	<ul style="list-style-type: none"> • Periksa apakah wadah debu penuh atau tersumbat. Kosongkan wadah debu. • Bersihkan atau ganti filter.
Air telah terisap ke dalam penyedot debu	Penting untuk mengganti motor di <i>pusat layanan</i> resmi Electrolux. Kerusakan pada motor yang disebabkan oleh masuknya air tidak termasuk dalam garansi
Untuk masalah lebih lanjut, hubungi <i>pusat layanan</i> resmi Electrolux.	

안전수칙 및 경고

본 제품은 안전에 관해 책임이 있는 사람이 제품 사용에 대한 감독 및 지시를 하는 경우, 8세 이상의 어린이, 신체 감각 또는 정신 능력이 낮거나 경험 및 지식이 부족한 사람도 사용할 수 있습니다.

경고: 터보 노즐*에는 이물질이 감길 수 있는 회전브러쉬가 있습니다. 청소기는 주의해서 사용하십시오. 회전브러쉬 사이에 끼인 이물질을 제거하거나 브러쉬를 청소하기 전에는 진공 청소기의 전원을 끄십시오.

*특정 모델만 해당.

어린이가 제품을 가지고 놀지 못하도록 지켜보아야 합니다.

청소와 유지보수는 감독 없이 어린이 혼자서 해서는 안 됩니다.

제품을 청소하거나 유지보수하기 전에는 항상 청소기 전원을 꺼야 합니다.

진공 청소기를 필터 없이 절대 사용하지 마십시오.

주의

이 제품에는 전기 연결부가 포함되어 있습니다.

- 진공 청소기로 액체를 청소하지 마십시오.
 - 청소하기 위해 액체에 담그지 마십시오.
 - 호스는 정기적으로 점검해야 하고 손상된 경우 사용해서는 안 됩니다.
- 상기 사항은 모터에 심각한 손상을 야기할 수 있고 보증 대상에 적용되지 않습니다. 이 진공 청소기는 가정용입니다.

진공 청소기를 절대 사용해서는 안 되는 곳

- 인화성 기체, 가연성 물질 등이 근처에 있는 경우
- 날카로운 물체 위에서 사용하는 경우
- 뜨겁거나 식은 재, 불씨가 있는 담배 꽂초 등
- 가루 세제, 석고, 콘크리트 먼지 또는 재를 포함한 미세먼지가 많은 경우

전원 케이블 안전 수칙

- 플러그 및 코드가 손상되지 않았는지 정기적으로 점검하십시오. 코드가 손상된 경우 절대로 진공 청소기를 사용하지 마십시오.
 - 코드가 손상된 경우, 위험을 방지하려면 공인 Electrolux 서비스 센터에서만 교체해야 합니다. 고객과실로 인한 청소기의 코드 손상은 보증 대상에 적용되지 않습니다.
 - 절대로 진공 청소기를 코드로 당기거나 들어올리지 마십시오.
- 모든 서비스와 수리는 공인 Electrolux 서비스 센터에서 수행되어야 합니다. 진공 청소기는 건조한 곳에 보관하십시오. 청소기나 사용 설명서에 대해 의견이 있을 경우, floorcare@electrolux.com으로 이메일을 보내 주십시오.

지속 가능성 정책

본 제품은 환경을 염두에 두고 설계되었습니다. 모든 플라스틱 부품은 재활용으로 표시되어 있습니다. 자세한 내용은 당사의 웹사이트, www.electrolux.com을 참조하십시오. 포장재는 환경 친화적인 자재를 사용했으므로 재활용할 수 있습니다. 기호 ♻️가 표시된 자재는 재활용하십시오. 포장재는 재활용이 가능합니다. 환경과 인류의 건강을 보호하고 전기 및 전자 제품의 폐기물을 재활용할 수 있도록 합니다. 기호 ♻️가 표시된 제품을 가정용 쓰레기와 함께 버리지 마십시오. 제품을 지역 재활용시설로 반환하거나 시청에 문의하십시오. 에너지 라벨의 공시 값은 필요한 측정법에 따라 측정되었습니다. (EN60312-1).

문제	해결책
진공 청소기가 작동되지 않음	<ul style="list-style-type: none"> • 케이블이 본체에 연결되었는지 점검하십시오. • 플러그 및 케이블이 손상되지 않았는지 점검하십시오. • 퓨즈가 끊어지지 않았는지 점검하십시오.
청소기 고장	<p>청소기가 과열되었을 수 있습니다. 전원에서 분리한 다음 노즐, 튜브, 호스 또는 필터가 막히지 않았는지 점검하십시오. 플러그를 다시 꽂기 전에 30분간 청소기의 열을 식히십시오. 여전히 청소기가 작동하지 않을 경우, 공인 Electrolux 서비스 센터에 문의하십시오.</p>
흡입력 감소	<ul style="list-style-type: none"> • 먼지통이 꽉 찼거나 막혔는지 점검하십시오. • 노즐, 튜브 호스 또는 필터가 막혔는지 점검하십시오. • 먼지통 및 필터가 제자리에 있는지 점검하십시오. 필터를 청소하거나 교체하십시오. 호스가 손상된 경우 반드시 교체해야 합니다.
호스 청소	<p>호스를 "딱 쥐어서" 청소하십시오. 단, 호스 내부에 유리나 바늘이 걸려서 막혀 있는 경우에는 각별히 조심하십시오. 참고: 호스를 청소함으로써 발생한 모든 호스 손상은 보증 대상에 적용되지 않습니다.</p>
진공 청소기가 과열되었습니다.	<ul style="list-style-type: none"> • 먼지통이 꽉 찼거나 막혔는지 점검하십시오. 먼지통을 비우십시오. • 필터를 청소하거나 교체하십시오.
진공 청소기 안으로 물이 빨려 들어갔습니다.	<p>공인 Electrolux 서비스 센터에서 모터를 교체해야 합니다. 물이 침투되어 발생한 모터 손상은 보증 대상에 적용되지 않습니다.</p>
다른 문제가 있는 경우, 공인 Electrolux 서비스 센터에 문의하십시오.	

ข้อกำหนดด้านความปลอดภัยและคำเตือน

อุปกรณ์นี้สามารถใช้กับเด็กอายุ 8 ปีขึ้นไป และผู้ที่มีสมรรถภาพทางกาย การรับรู้และจิตใจที่ไม่บกพร่อง หรือขาดประสบการณ์และความรู้ถ้าได้รับคำแนะนำหรือการสอนการใช้งานเกี่ยวกับการใช้เครื่องอย่างปลอดภัย และเข้าใจถึงอันตรายที่เกี่ยวข้อง

คำเตือน: ท่อเทอร์โบ * มีแปรงแบบหมุนที่ชิ้นส่วนอาจถูกติดค้างอยู่ โปรดใช้งานด้วยความระมัดระวังและใช้เฉพาะบนพื้นผิวที่กำหนดไว้เท่านั้น กรุณาปิดเครื่องดูดฝุ่นก่อนนำชิ้นส่วนที่ติดค้างหรือทำความสะอาดแปรง *เฉพาะบางรุ่นเท่านั้น เด็กควรได้รับการดูแลเพื่อให้แน่ใจว่าไม่นำเครื่องไปเล่น ห้ามเด็กทำความสะอาดและดูแลรักษาเครื่องหากไม่มีคนคอยดูแล ถอดปลั๊กออกจากเต้ารับเสมอก่อนทำความสะอาดหรือซ่อมบำรุงเครื่อง ห้ามใช้เครื่องดูดฝุ่นที่ไม่ได้ใส่ตัวกรอง

ข้อควรระวัง

อุปกรณ์นี้มีการต่อกับไฟฟ้า

- ห้ามใช้ดูดของเหลวใดๆ
- อย่าจุ่มลงในน้ำยาใดๆ เพื่อทำความสะอาด
- ควรตรวจสอบท่ออย่างสม่ำเสมอและไม่ควรใช้งาน หากมีความเสียหาย

ในด้านบนอาจก่อให้เกิดความเสียหายร้ายแรงต่อมอเตอร์ซึ่งไม่ได้รับการคุ้มครองจากการรับประกัน เครื่องดูดฝุ่นนี้เหมาะสำหรับใช้ภายในบ้านเท่านั้น

อย่าใช้เครื่องดูดฝุ่น

- ใกล้กับก๊าซไวไฟ ฯลฯ
- บนวัตถุมีคม
- ดูดซี้เก้าร้อนหรือเย็น ก้นบุหรี่ติดไฟ ฯลฯ
- ดูดฝุ่นผงละเอียด เช่น จากปูนพลาสเตอร์ คอนกรีต แป้ง

ข้อควรระวังเกี่ยวกับสายไฟ

- ตรวจสอบอย่างสม่ำเสมอว่าปลั๊กและสายไฟไม่มีความเสียหาย ห้ามใช้เครื่องดูดฝุ่นที่สายไฟมีความเสียหาย
- หากสายไฟชำรุดเสียหายต้องเปลี่ยนเฉพาะกับศูนย์บริการ Electrolux ที่ได้รับอนุญาตเท่านั้น เพื่อหลีกเลี่ยงอันตราย ความเสียหายที่เกิดขึ้นกับสายไฟของเครื่องดูดฝุ่นไม่ได้รับการคุ้มครองจากการรับประกัน
- อย่าดึงหรือยกเครื่องดูดฝุ่นด้วยการยกสายไฟ

การบริการและการซ่อมแซมทั้งหมดจะต้องดำเนินการโดยศูนย์บริการของ Electrolux ที่ได้รับอนุญาตเท่านั้น เก็บเครื่องดูดฝุ่นไว้ในที่แห้ง

ข้อมูลสำหรับผู้บริโภค

Electrolux ปฏิเสธความรับผิดชอบทั้งหมดต่อความเสียหายทั้งหมดที่เกิดขึ้นจากการใช้เครื่องที่ไม่เหมาะสมหรือในกรณีที่มีการดัดแปลงเครื่อง สำหรับรายละเอียดเพิ่มเติมเกี่ยวกับการรับประกันและที่ติดต่อของผู้บริโภค โปรดดูที่คู่มือ การรับประกัน ภายในกล่อง หากคุณมีข้อคิดเห็นใดๆ เกี่ยวกับเครื่องดูดฝุ่นหรือคู่มือการใช้งาน โปรดส่งอีเมลมาที่ floorcare@electrolux.com

นโยบายด้านความยั่งยืน

ผลิตภัณฑ์นี้ได้รับการออกแบบโดยคำนึงถึงสิ่งแวดล้อม ชิ้นส่วนพลาสติกทั้งหมดมีเครื่องหมายสำหรับการรีไซเคิล ดูรายละเอียดได้จากเว็บไซต์ของเราที่: www.electrolux.com วัสดุบรรจุภัณฑ์ถูกเลือกให้เป็นมิตรต่อสิ่งแวดล้อมและสามารถรีไซเคิลได้ รีไซเคิลวัสดุที่มีสัญลักษณ์ ♻️ ในบรรจุภัณฑ์ลงในภาชนะที่ใช้แล้วนำมารีไซเคิลได้ ช่วยปกป้องสิ่งแวดล้อมและสุขภาพของมนุษย์และรีไซเคิลของเสียจากเครื่องใช้ไฟฟ้าและอิเล็กทรอนิกส์ ห้ามทิ้งเครื่องใช้ที่มีเครื่องหมาย **WEEE** แสดงไว้ร่วมกับขยะในบ้าน ส่งคืนผลิตภัณฑ์ไปยังสถานที่รีไซเคิลในพื้นที่หรือติดต่อสำนักงานเทศบาลของคุณ ค่าที่ประกาศในฉลากพลังงานจะวัดตามวิธีการวัดที่กำหนดไว้ให้ (EN60312-1)

ปัญหา	การแก้ไข
เครื่องดูดฝุ่นไม่เริ่มทำงาน	<ul style="list-style-type: none">ตรวจสอบว่าสายไฟเสียบปลั๊กไฟหรือไม่ ตรวจสอบว่าปลั๊กและสายไฟไม่มีความเสียหาย ตรวจสอบว่าฟิวส์ขาดหรือไม่
เครื่องหยุดทำงาน	เครื่องอาจเกิดความร้อนสูงเกินไป: ถอดสายไฟออก ตรวจสอบว่าท่อ สายยางหรือตัวกรองอุดตันหรือไม่ ทิ้งให้ตัวเครื่องเย็นลงเป็นเวลา 30 นาทีก่อนเสียบปลั๊กอีกครั้ง หากเครื่องยังไม่ทำงาน ให้ติดต่อศูนย์บริการ Electrolux ที่ได้รับอนุญาต
ลดกำลังการดูด	<ul style="list-style-type: none">ตรวจสอบว่าที่เก็บฝุ่นเต็มหรืออุดตันหรือไม่ ตรวจสอบว่าท่อ สายยางหรือตัวกรองอุดตันหรือไม่ ตรวจสอบว่าที่เก็บฝุ่นและตัวกรองอยู่ในตำแหน่งหรือไม่ ทำความสะอาดหรือเปลี่ยนตัวกรอง ถ้าท่อเสียหายจะต้องเปลี่ยนใหม่
ล้าंगท่อสายยาง	ล้าंगท่อดูดโดยการ “บีบ” อย่างไรก็ตามโปรดระมัดระวังในกรณีที่เกิดการอุดตันจากแก้วหรือเข็มที่ติดอยู่ภายในท่อ <p>หมายเหตุ: การรับประกันไม่ครอบคลุมถึงความเสียหายที่เกิดจากการทำความสะอาดท่อดูด</p>
เครื่องดูดฝุ่นร้อนเกินไป	<ul style="list-style-type: none">ตรวจสอบว่าที่เก็บฝุ่นเต็มหรืออุดตันหรือไม่ เทฝุ่นออกจากที่เก็บฝุ่นให้หมด ทำความสะอาดหรือเปลี่ยนตัวกรอง
น้ำถูกดูดเข้าไปในเครื่องดูดฝุ่น	จำเป็นต้องเปลี่ยนมอเตอร์กับศูนย์บริการ Electrolux ที่ได้รับอนุญาต ความเสียหายที่เกิดกับมอเตอร์ที่เกิดจากการซึมผ่านของน้ำ จะไม่ได้รับการคุ้มครองโดยการรับประกัน
หากมีปัญหาเพิ่มเติมโปรดติดต่อศูนย์บริการ Electrolux ที่ได้รับอนุญาต	

安全要求和警告

本產品可供8歲以上的兒童，以及在身體、感官或智力方面存在障礙，或缺乏經驗和知識的人員使用，但必須對他們加以監護或給予安全使用產品的指導，並讓他們瞭解相關危險。

警告：渦輪吸頭*有一個旋轉刷頭，小零件可能被卡在其中，請小心使用，且僅用於規定的表面。在取出被卡住的小零件或清潔刷頭之前，請先關閉吸塵器的電源。*僅適用特定型號。

注意看管兒童，確保他們不玩弄本產品。

不得在無人監管的情況下，讓兒童清潔和維護本產品。

清潔或維護本產品時，務必斷開插頭與主電源的連接。

切勿在未安裝濾網的情況下使用吸塵器。

注意

本產品內含電氣連接。

- 切勿用此吸取任何液體。
- 切勿將其浸沒在任何液體中進行清潔。
- 應定期檢查軟管，如有損壞，不得使用。

違反上述要求可能導致馬達嚴重損傷，此後果不在保證範圍之內。

本吸塵器僅供家庭使用。

切勿在以下情況下使用吸塵器

- 靠近易燃氣體等。
- 存在鋒利物體。
- 存在高溫或低溫的餘燼、未熄滅的煙蒂等物品等。
- 存在細末粉塵（例如石膏粉、水泥、麵粉）。

電源線防範措施

- 定期檢查插頭和電源線，確保它們未損壞。如果電源線損壞，切勿使用吸塵器。
- 如果電源線受損，為避免造成危險，只能由授權的伊萊克斯服務中心進行更換。吸塵器電源線受損不在保證範圍之內。
- 切勿用電源線拉扯或提起吸塵器。

所有維修或維護必須由授權的伊萊克斯服務中心進行。

請將吸塵器存放在乾燥的位置。

消費者資訊

對於因不當使用或擅自改動本產品而引起的任何損害，伊萊克斯概不承擔任何責任。有關保證和消費者聯絡方式的更多詳細資訊，請參見包裝中的《保固手冊》。如果您對吸塵器或操作說明手冊有任何意見，可至官網 www.electrolux.com。

可持續性政策

本產品設計心繫環保理念。所有塑膠部件均已標識以便於回收。有關詳情，請造訪我們的網站：

www.electrolux.com。

包裝材料採用環保材料，可回收利用。

回收帶有  標誌的材料。將包裝材料放入相應的容器進行回收。幫助保護環境和人類健康，回收利用電器及電子產品的廢物。

請勿將帶有  標誌的電器與生活垃圾一起處理。將產品退回到您當地的回收處。

能量標籤上標明的數值是根據規定的測量方法(EN60312-1)測量所得。

客戶說明

有鑒於世界各國對綠色環保意識的重視，伊萊克斯依循 RoHS「危害性限制物質指令」誠實標示產品化學物質含量，關於本產品的 RoHS 聲明書，請上伊萊克斯官網-->「支援服務」-->「RoHS 聲明書」，依產品類別及型號檢索。

<http://www.electrolux.com.tw/Support/Customer-Care/>

問題	解決方案
真空吸塵器不啟動	<ul style="list-style-type: none"> • 檢查電線是否連接至電源。 • 檢查插頭和電線是否破損。 • 檢查保險絲是否熔斷。
吸塵器停止運轉	可能是吸塵器過熱：斷開主電源連接；檢查吸頭、伸縮管、軟管或濾網是否堵塞。吸塵器冷卻 30 分鐘後再連接電源。如吸塵器仍無法使用，請聯絡授權的伊萊克斯服務中心。
吸力下降	<ul style="list-style-type: none"> • 檢查集塵盒是否已滿或堵塞。 • 檢查吸頭、伸縮管、軟管或濾網是否堵塞。 • 檢查集塵盒和濾網是否恰當固定。清潔或更換濾網。若軟管損壞，則需更換軟管。
清理軟管	用「推擠」的方式清理軟管。但若阻塞是由軟管內的玻璃或針狀物體引致，請務必小心。 注意：對於清潔軟管導致的任何損傷，均不在保固範圍內。
真空吸塵器過熱	<ul style="list-style-type: none"> • 檢查集塵盒是否已滿或堵塞。清空集塵盒。 • 清潔或更換濾網。
真空吸塵器進水	必須送至授權的伊萊克斯服務中心更換馬達。因進水導致馬達損壞，不在保固範圍內。
如有任何其他問題，請聯絡授權的伊萊克斯服務中心。	

Yêu cầu và cảnh báo về an toàn

Trẻ em từ 8 tuổi trở lên và người bị suy giảm thể chất, giác quan, thiếu năng trí tuệ hoặc thiếu kinh nghiệm và kiến thức có thể sử dụng thiết bị này nếu họ được giám sát hoặc hướng dẫn sử dụng an toàn và hiểu những mối nguy hiểm có thể xảy ra.

CẢNH BÁO: Đầu hút tuabin* có chổi xoay trong đó các bộ phận có thể bị mắc kẹt. Vui lòng sử dụng các đầu hút này thận trọng và chỉ dùng trên các bề mặt dự kiến sử dụng. Vui lòng tắt máy hút bụi trước khi tháo các bộ phận mắc kẹt hoặc làm vệ sinh chổi. **Chỉ có ở một số model.*

Trẻ em phải được giám sát để đảm bảo chúng không nghịch phá thiết bị này.

Trẻ em không được vệ sinh và bảo trì thiết bị nếu không được giám sát.

Luôn tháo phích cắm khỏi mạch điện chính trước khi làm vệ sinh hoặc bảo trì thiết bị.

Không bao giờ sử dụng máy hút bụi mà không có bộ lọc của nó.

Thận trọng

Thiết bị này có các kết nối điện.

- Không bao giờ được hút bất kỳ chất lỏng nào.
- Không được nhúng vào bất kỳ chất lỏng nào để vệ sinh.
- Phải thường xuyên kiểm tra ống và không được sử dụng nếu ống bị hỏng.

Các hành động trên có thể gây hỏng nặng cho động cơ và sẽ không được bảo hành.

Chỉ sử dụng máy hút bụi này trong nhà.

Không bao giờ sử dụng máy hút bụi

- Ở gần các chất khí dễ cháy, v.v..
- Trên các vật sắc.
- Trên than xỉ nóng hoặc lạnh, mẫu thuốc lá đang cháy, v.v..
- Trên các loại bụi mịn, ví dụ: thạch cao, xi măng, bột mì.

Biện pháp phòng ngừa đối với dây điện

- Thường xuyên kiểm tra để đảm bảo rằng phích cắm và dây điện không bị hỏng. Không bao giờ sử dụng máy hút bụi nếu dây bị hỏng.
- Nếu dây bị hỏng, chỉ có trung tâm dịch vụ được ủy quyền của Electrolux mới được thay thế dây để tránh nguy hiểm. Hư hỏng đối với dây của máy hút bụi không được bảo hành.
- Không bao giờ được kéo hay nhấc máy hút bụi bằng dây.

Mọi việc bảo dưỡng và sửa chữa phải do trung tâm dịch vụ được ủy quyền của Electrolux thực hiện.

Cắt máy hút bụi ở nơi khô ráo.

Thông tin dành cho người tiêu dùng

Electrolux khước từ mọi trách nhiệm về mọi hư hỏng phát sinh do sử dụng thiết bị không đúng cách hoặc trong các trường hợp phá hoại thiết bị này. Để biết thêm thông tin chi tiết về bảo hành và người liên hệ dành cho người tiêu dùng, hãy xem Sổ tay Bảo hành trong hộp. Nếu bạn có bất kỳ nhận xét nào về máy hút bụi hoặc tài liệu Hướng dẫn Vận hành, vui lòng gửi email cho chúng tôi theo địa chỉ floorcare@electrolux.com.

Chính sách về sự bền vững

Sản phẩm này được thiết kế có quan tâm đến bảo vệ môi trường. Mọi bộ phận nhựa đều được đánh dấu cho các mục đích tái chế. Để biết chi tiết, hãy xem trang web của chúng tôi: www.electrolux.com.

Vật liệu đóng gói được lựa chọn để thân thiện với môi trường và có thể tái chế.

Hãy cho tái chế các vật liệu có biểu tượng . Đặt hộp vào thùng chứa thích hợp để tái chế. Hãy góp phần bảo vệ môi trường, sức khỏe con người và tái chế rác thải từ các thiết bị điện và điện tử.

Không thải loại các thiết bị được đánh dấu bằng biểu tượng  với chất thải sinh hoạt. Hãy chuyển sản

phẩm này tới cơ sở tái chế tại địa phương hoặc liên hệ với cơ quan thành phố của bạn.

Giá trị tuyên bố trên nhãn năng lượng được đo lường theo phương pháp đo lường được yêu cầu (EN60312-1).

Sự cố	Giải pháp
Máy hút bụi không khởi động	<ul style="list-style-type: none"> • Kiểm tra để đảm bảo rằng dây điện được kết nối với nguồn điện. • Kiểm tra để đảm bảo rằng phích cắm và dây điện không hư hỏng. • Kiểm tra xem cầu chì có ngắt.
Máy hút bụi không hoạt động	Máy hút bụi có thể bị quá nóng: hãy ngắt kết nguồn điện của máy; kiểm tra xem đầu hút, ống cứng, ống mềm hoặc màng lọc có bị tắc nghẽn không. Để máy hút bụi nguội dần trong 30 phút trước khi cắm máy trở lại. Nếu máy vẫn không hoạt động, hãy liên hệ với trung tâm dịch vụ được ủy quyền của Electrolux.
Công suất hút giảm	<ul style="list-style-type: none"> • Kiểm tra xem hộp chứa bụi có bị đầy hay tắc nghẽn không. • Kiểm tra xem đầu hút, ống cứng, ống mềm hoặc màng lọc có bị tắc nghẽn không. • Kiểm tra xem đã lắp hộp chứa bụi và màng lọc chưa. Vệ sinh hoặc thay thế màng lọc. Nếu ống mềm hỏng, cần thay ống này.
Vệ sinh ống mềm	Vệ sinh ống mềm bằng cách "ép chặt" ống. Tuy nhiên, hãy cẩn thận trong trường hợp ống bị tắc do thủy tinh hoặc kim mắc kẹt bên trong. Lưu ý: Chế độ bảo hành không bao gồm bất kỳ trường hợp hư hỏng nào ở ống mềm gây ra do việc vệ sinh ống mềm.
Máy hút bụi quá nóng	<ul style="list-style-type: none"> • Kiểm tra xem hộp chứa bụi có bị đầy hay tắc nghẽn không. Làm sạch hộp chứa bụi. • Vệ sinh hoặc thay thế màng lọc.
Nước bị hút vào trong máy hút bụi.	Cần thay thế động cơ tại trung tâm dịch vụ được ủy quyền của Electrolux. Trường hợp hư hỏng đối với động cơ do nước xâm nhập không được bảo hành.
Đối với bất kỳ sự cố nào khác, hãy liên hệ với trung tâm dịch vụ được ủy quyền của Electrolux.	

中国

伊莱克斯（中国）电器有限公司上海小家电分公司
中国，上海，静安区共和新路1968号大宁国际广场
8号楼606室
办公电话: +86 21 3178 1000
传真: +86 21 3387 0368
售后服务: +86 9510 5801
服务邮箱: saservice.china@electrolux.com
网站: www.electrolux.com.cn

台灣

新加坡商伊莱克斯股份有限公司 台灣分公司
22065新北市板橋區縣民大道2段68號9F
免付費客服專線: 0800-888-259
傳真: 886-2-8964-5269
電郵: service@electrolux.com.tw
網站: www.electrolux.com.tw

KOREA

Electrolux Korea limited
9F, Pine Avenue B,
100 Euljiro, Jung-gu, Seoul, Korea 04551
Tel : +(82) 2 6020-2200
Fax: +(82) 2 6020-2271~3
Customer Care Services : +(82) 1566-1238
Email : homecare.krh@electrolux.com
Website: www.electrolux.co.kr

INDONESIA

PT. Electrolux Indonesia
Electrolux Building
Jl. Abdul Muis no. 34, Petojo Selatan,
Gambir, Jakarta Pusat 10160,
Tel: +(62) 21 5081 7300
Fax: +(62) 21 5081 7399
Customer Care Services: +(62) 0804 111 9999
Email: customercare@electrolux.co.id
Website: www.electrolux.co.id
DEPDAG : I.31.EI6.00334.0119

PHILIPPINES

Electrolux Philippines Inc.
10th Floor. W5th Avenue Building
5th Avenue Corner 32nd Street
Bonifacio Global City,
Taguig Philippines 1634
Tel: +(63) 2 737 4757
Domestic Toll Free : 1 800 10 845 care 2273
Customer Care Services: +(63) 2 845 care 2273
Email: wecare@electrolux.com
Website: www.electrolux.com.ph

THAILAND

Electrolux Thailand Co Ltd
Electrolux Building
14th Floor 1910 New Petchburi Road
Bangkapi, Huay Kwang
Bangkok 10310
Thailand
Tel: +(66) 2 725 9100
Fax: +(66) 2 725 9299
Customer Care Services: +(66) 2 725 9000
Email: customercarethai@electrolux.com
Website: www.electrolux.co.th

VIETNAM

Electrolux Vietnam Ltd
Floor 9th, A&B Tower
76 Le Lai Street
Ben Thanh Ward - District 1
Ho Chi Minh City
Vietnam
Tel: +(84) 8 3910 5465
Fax: +(84) 8 3910 5470
Customer Care Services: 1800-58-8899
Email: vncare@electrolux.com
Website: www.electrolux.vn

MALAYSIA

Electrolux Home Appliances Sdn Bhd
Lot C6, No. 28, Jalan 15/22,
Taman Perindustrian Tiong Nam,
40200 Shah Alam, Selangor
Malaysia
Customer Care Hotline: 1300-88-11-22
Customer Care Services Tel: (+60 3) 5525 0800
Customer Care Services Fax: (+60 3) 5524 2521
Email: malaysia.customercare@electrolux.com
Website: www.electrolux.com.my

SINGAPORE

Electrolux S.E.A Pte Ltd
351 Braddell Rd, #01-04, Singapore 579713
Fax: +(65) 6727 3611
Customer Care Services: +(65) 6727 3699
Email: customer-care.sin@electrolux.com
Website: www.electrolux.com.sg

HONG KONG

大昌貿易行有限公司
電器維修中心
香港九龍灣啟祥道20號
大昌行集團大廈5樓
服務熱線: +(852) 3193 9888
電子郵件: dthead@ead.dch.com.hk
網頁: www.electrolux.com.hk

AUSTRALIA

Electrolux Home Care & Small Domestic Appliances
ABN 51 004 762 341
163 O'Riordan Street, Mascot, NSW 2020, Australia
Customer Service Phone: 13 13 49
Customer Service email: customercare@electrolux.com.au
Website: www.electrolux.com

NEW ZEALAND

Electrolux Home Care & Small Domestic Appliances
A division of Electrolux (NZ) Limited
3-5 Niall Burgess Road, Mt Wellington,
Auckland, New Zealand
Phone: (09) 573 2220
Customer Service Phone: 008 436 245
Customer Service email: customercare@electrolux.co.nz
Website: www.electrolux.com