

ETB2302J-A	ETB2302J-H	EBB2802K-A	EBB2802K-H
ETB2502J-A	ETB2502J-H	EBB3402K-A	EBB3402K-H
ETB2802J-A	ETB2802J-H	EBB3442K-A	EBB3442K-H
ETB3400K-A	ETB3400K-H	EBB3462K-A	EBB3462K-H
ETB3440K-A	ETB3440K-H	EBB3702K-A	EBB3702K-H
ETB3460K-A	ETB3460K-H	EBB3742K-A	EBB3742K-H
ETB3700K-A	ETB3700K-H	EBB3762K-A	EBB3762K-H
ETB3740K-A	ETB3740K-H		
ETB3760K-A	ETB3760K-H		

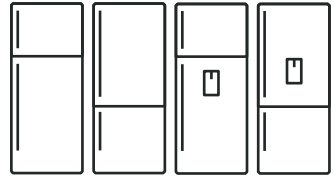

CONTENTS

1. SAFETY INFORMATION	3
2. DESCRIPTION OF THE APPLIANCE	5
3. CONTROL PANEL	19
4. INSTALLING YOUR NEW APPLIANCE	24
5. USING YOUR REFRIGERATOR	25
6. AUTOMATIC ICE MAKER	29
7. CLEANING YOUR REFRIGERATOR	30
8. FOOD STORAGE GUIDE	31
9. TROUBLESHOOTING	32
10. NOISES	35

WE'RE THINKING OF YOU

Thank you for choosing Electrolux. We have designed this product to make your life simpler and deliver impeccable performance for many years. Please spend a few minutes reading this document to get the best from your new Electrolux appliance.

Visit our website to:



Get usage advice or service information
www.electrolux.com



Register your product for better service:
www.electrolux.com/support/register-warranty

CUSTOMER CARE AND SERVICE

Always use original spare parts.

When contacting our Authorised Service Centre, ensure that you have the following data available: Model, PNC, Serial Number.

The information can be found on the rating plate.

 Warning / Caution-Safety information.

 General information and tips.

 Environmental information.

Subject to change without notice.

1. SAFETY INFORMATION

Note: You must read these warnings carefully before installing or using the refrigerator. If you need assistance, contact your customer care centre. The manufacturer will not accept liability, should these instructions or any other safety instructions incorporated in this book be ignored.



WARNING

- It is essential the electric outlet is properly earthed to ground. Consult a qualified electrician if you are unsure.
- Do not use electrical appliances inside the food storage compartments of the appliance, unless they are of the type recommended by the manufacturer.
- Unplug the refrigerator before cleaning or moving it to avoid electric shock.
- Never unplug the refrigerator by pulling the electrical cord as this may damage it. Grip the plug firmly and pull straight out.
- If the power cord is damaged, it must be replaced by the manufacturer, its service agent or similarly qualified persons in order to avoid a hazard
- Don't use a steam cleaner. If live components come into contact with condensing steam, they may short-circuit or cause an electric shock.
- Do not store explosive substances such as aerosol cans with a flammable propellant this appliance. If pressurised aerosol containers bear the word 'flammable' and/or a small flame symbol, do not store them inside any refrigerator or freezer. If you do so you may cause an explosion.
- Do not damage the refrigerant circuit.
- This appliance contains insulation formed with flammable blowing gases. Avoid safety hazards by carefully disposing of this appliance.
- If you wish to discard this refrigerator, please contact your local authorities and ask for the correct method of disposal.
- When you dispose of your old refrigerators and freezers, remove any doors. Children can suffocate if they get trapped inside.
- When positioning the appliance, ensure the supply cord is not trapped or damaged.
- Do not locate multiple portable socket-outlets or portable power supplies at the rear of the appliance.



WARNING

R600a refrigerant warning



This appliance contains flammable R600a refrigerant. Avoid safety hazards by carefully installing, handling, servicing and disposing of this appliance.

- Ensure that the tubing of the refrigerant circuit is not damaged during transportation and installation.
- Leaking refrigerant may cause eye injuries or ignite.
- The room for installing appliance must be at least 1m³ per 8g of refrigerant. The amount of refrigerant in the appliance can be found on the rating plate inside the appliance.
- If you are unsure of the refrigerant check the rating plate inside the refrigerator compartment.
- It is hazardous for anyone other than an Authorised Service Person to service this appliance. In Queensland Australia the Authorisation Service Person MUST hold a Gas Work Authorisation for hydrocarbon refrigerants to carry out servicing or repairs which involve the removal of covers.
- Keep ventilation openings in the appliance enclosure or in the built-in structure, clear of obstruction.
- Do not use mechanical devices or other means to accelerate the defrosting process, other than those recommended by the manufacturer.



WARNING

Stable Footing

When your refrigerator is in place, you need to stabilise it. Lift the front of the refrigerator to take the weight off each stability foot and make small quarter turns to each foot until it is in firm contact with the floor. If you intend to move the refrigerator, remember to wind up each foot so that you can move it freely. Repeat the process of the foot adjustment once you have settled on the new location of the refrigerator.

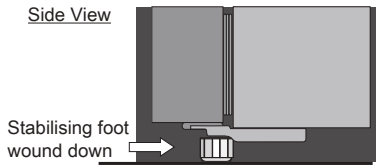

GENERAL WARNINGS

Read the following carefully to avoid damage or injury. It is important to use your refrigerator safely. Check these safety points before using your refrigerator.

- The appliance must be plugged into its own dedicated electrical outlet.
- The plug must be accessible when the refrigerator is in position.
- It is essential the powerpoint is properly earthed to ground. Consult a qualified electrician if you are unsure.
- Don't use extension cords or adapter plugs with this refrigerator.
- If the supply cord is damaged, it must be replaced by the manufacturer, its service agent or similarly qualified persons in order to avoid a hazard.
- Unplug the appliance before cleaning and before changing the light bulb (when fitted) to avoid electric shock.
- Never unplug the refrigerator by pulling the electrical cord as this may damage it. Grip the plug firmly and pull straight out.
- Choose a location for your refrigerator that isn't too cold. The ambient room temperature should be above 10°C.
- Stand your refrigerator in a dry place avoid areas of high moisture or humidity.
- Don't put the refrigerator in frosty or unprotected areas like a garage or on the verandah.
- Don't plug your refrigerator into a timer fitted to the powerpoint.
- Do not put the refrigerator in direct sunlight, near stoves, fires or heaters.
- Do not put the refrigerator on an uneven surface.
- Do not store flammable materials on or under the appliance, e.g. aerosols.
- Do not store explosive substances such as aerosol cans with a flammable propellant in this appliance.
- Never store fizzy drinks in the freezer compartment.

- Never try to repair the refrigerator yourself, only use a qualified or authorised service person for repairs.
- Never use electric heaters or dryers to defrost the freezer because you can receive an electric shock
- When transporting and installing the refrigerator, care should be taken to ensure that no parts of the refrigerating circuit are damaged.
- Keep ventilation openings in the appliance enclosure or in the built-in structure clear of obstruction.
- When installed correctly, your refrigerator should:
 - Have adequate space at the back and sides for air circulation.
 - Be vertically aligned to the surrounding cupboards.
 - Have doors that will self-close from a partially open position.
- The appliance is not to be used by persons (including children) with reduced physical, sensory or mental capabilities, or lack of experience and knowledge, unless they have been given supervision or instruction.
- Children being supervised not to play with the appliance.

NOTE: You must read these warnings carefully before installing or using the refrigerator. If you need assistance, contact your Customer Care Department. The manufacturer will not accept liability, should these instructions or any other safety instructions incorporated in this book be ignored.



Environmental information.

This appliance is intended to be used in household and similar applications such as,

- The kitchen areas in shops, offices and other working environments;
- Farm house and by clients in hotels, motels and other residential type environments;
- Bed and breakfast type environments;
- Catering and similar non-retail applications;

2. DESCRIPTION OF THE APPLIANCE

TOP MOUNT REFRIGERATOR FEATURES

- ETB2302J-A • ETB2502J-A • ETB2802J-A
- ETB2302J-H • ETB2502J-H • ETB2802J-H

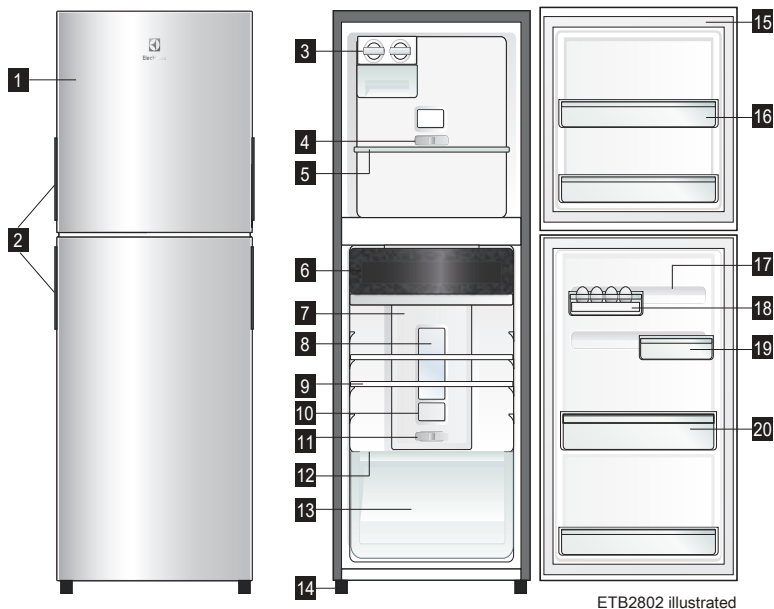

ETB2802 illustrated

The details of the refrigerator feature:

- | | |
|--|--|
| 1 Doors | 11 Slide Control Refrigerator Temperature |
| 2 Door Handles | 12 Humidity Slide |
| 3 Ice Twist & Serve | 13 Crisper |
| 4 Slide Control Freezer Temperature | 14 Feet |
| 5 Freezer Shelf | 15 Gaskets |
| 6 TasteSeal Room | 16 Door Bins |
| 7 Multi Flow | 17 FlexStor Rails |
| 8 Refrigerator Light | 18 Egg Tray |
| 9 Shelves | 19 FlexStor Bins |
| 10 Deodorizer Cover Refrigerator | 20 Bottle Bins |

Features may vary depending on model. Not all models will have features listed.

TOP MOUNT REFRIGERATOR FEATURES

- ETB3400K-A
- ETB3400K-H



ETB3400 illustrated

The details of the refrigerator feature:

- | | |
|--|--|
| 1 Door | 11 Crisper |
| 2 Door Handles | 12 Feet |
| 3 Ice Twist & Serve | 13 Gaskets |
| 4 Slide Control Freezer Temperature | 14 Door Bins Shallow |
| 5 Freezer Shelf | 15 Refrigerator Light |
| 6 TasteSeal Room | 16 Egg Tray |
| 7 Multi Flow | 17 Refrigerator Temperature Control Panel |
| 8 Metal Cover Deoderizer | 18 Door Bins Upper |
| 9 Shelves | 19 Bottle Bin |
| 10 Auto Humidity Control | |

Features may vary depending on model. Not all models will have features listed.

TOP MOUNT REFRIGERATOR FEATURES

- ETB3440K-A
- ETB3440K-H

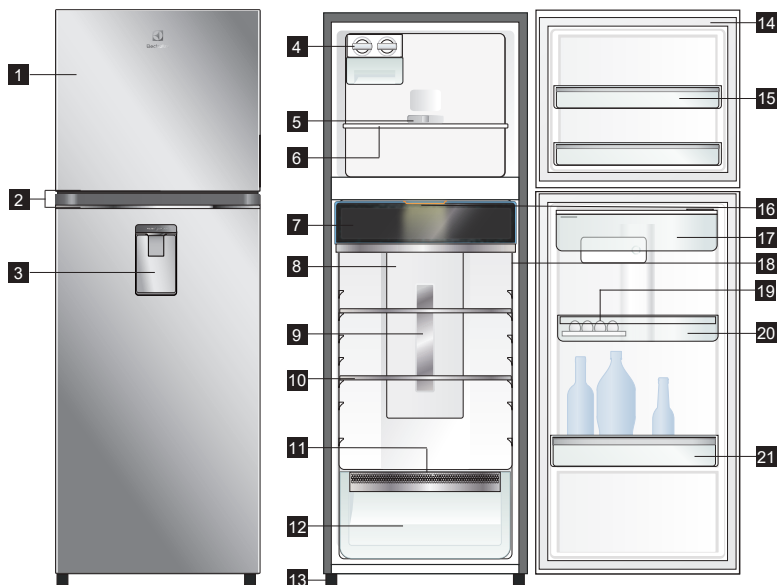

ETB3440 illustrated

The details of the refrigerator feature:

- | | |
|--|--|
| 1 Door | 12 Crisper |
| 2 Door Handles | 13 Feet |
| 3 Water Dispenser | 14 Gaskets |
| 4 Ice Twist & Serve | 15 Door Bins Shallow |
| 5 Slide Control Freezer Temperature | 16 Refrigerator Light |
| 6 Freezer Shelf | 17 Water Tank |
| 7 TasteSeal Room | 18 Refrigerator Temperature Control |
| 8 Multi Flow | 19 Panel Egg Tray |
| 9 Metal Cover Deoderizer | 20 Door Bin Upper |
| 10 Shelves | 21 Bottle Bin |
| 11 Auto Humidity Control | |

Features may vary depending on model. Not all models will have features listed.

TOP MOUNT REFRIGERATOR FEATURES

- ETB3460K-A
- ETB3460K-H



ETB3460 illustrated

The details of the refrigerator feature:

- | | |
|--|--|
| 1 Door | 12 Auto Humidity Control |
| 2 Door Handles | 13 Crisper |
| 3 Water Dispenser | 14 Feet |
| 4 Auto Ice Maker | 15 Gaskets |
| 5 Ice Bin | 16 Door Bins Shallow |
| 6 Slide Control Freezer Temperature | 17 Refrigerator Light |
| 7 Freezer Shelf | 18 Water Tank |
| 8 TasteSeal Room | 19 Refrigerator Temperature Control Panel |
| 9 Multi Flow | 20 Egg Tray |
| 10 Metal Cover Deoderizer | 21 Door Bin Upper |
| 11 Shelves | 22 Bottle Bin |

Features may vary depending on model. Not all models will have features listed.

TOP MOUNT REFRIGERATOR FEATURES

- ETB3700K-A
- ETB3700K-H



ETB3700 illustrated

The details of the refrigerator feature:

- | | |
|--|--|
| 1 Door | 11 Crisper |
| 2 Door Handles | 12 Feet |
| 3 Ice Twist & Serve | 13 Gaskets |
| 4 Slide Control Freezer Temperature | 14 Door Bins Shallow |
| 5 Freezer Shelf | 15 Refrigerator Light |
| 6 TasteSeal Room | 16 Egg Tray |
| 7 Multi Flow | 17 Refrigerator Temperature Control Panel |
| 8 Metal Cover Deoderizer | 18 Door Bins Upper |
| 9 Shelves | 19 Bottle Bin |
| 10 Auto Humidity Control | |

Features may vary depending on model. Not all models will have features listed.

TOP MOUNT REFRIGERATOR FEATURES

- ETB3740K-A
- ETB3740K-H

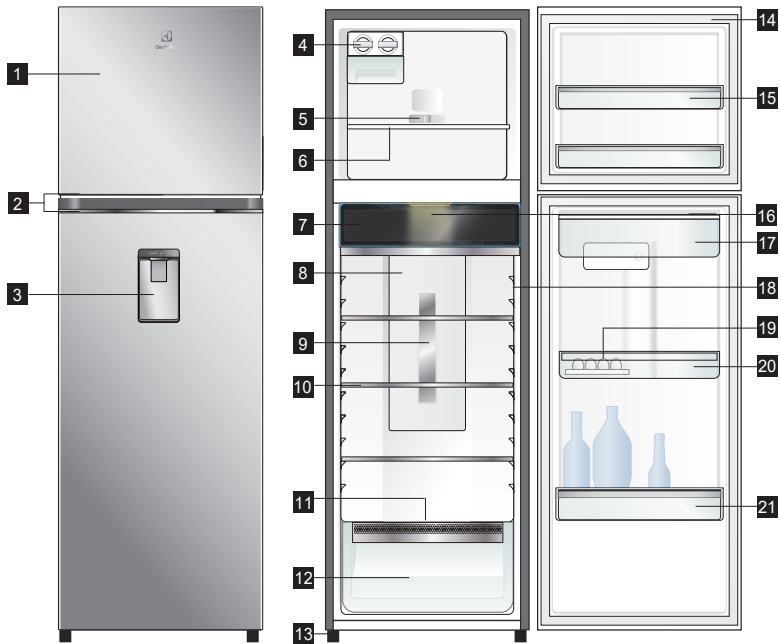

ETB3740 illustrated

The details of the refrigerator feature:

- | | |
|--|--|
| 1 Door | 12 Crisper |
| 2 Door Handles | 13 Feet |
| 3 Water Dispenser | 14 Gaskets |
| 4 Ice Twist & Serve | 15 Door Bins Shallow |
| 5 Slide Control Freezer Temperature | 16 Refrigerator Light |
| 6 Freezer Shelf | 17 Water Tank |
| 7 TasteSeal Room | 18 Refrigerator Temperature Control Panel |
| 8 Multi Flow | 19 Egg Tray |
| 9 Metal Cover Deoderizer | 20 Door Bin Upper |
| 10 Shelves | 21 Bottle Bin |
| 11 Auto Humidity Control | |

Features may vary depending on model. Not all models will have features listed.

TOP MOUNT REFRIGERATOR FEATURES

- ETB3760K-A
- ETB3760K-H



ETB3760 illustrated

The details of the refrigerator feature:

- | | |
|--|--|
| 1 Door | 12 Auto Humidity Control |
| 2 Door Handles | 13 Crisper |
| 3 Water Dispenser | 14 Feet |
| 4 Auto Ice Maker | 15 Gaskets |
| 5 Ice Bin | 16 Door Bins Shallow |
| 6 Slide Control Freezer Temperature | 17 Refrigerator Light |
| 7 Freezer Shelf | 18 Water Tank |
| 8 TasteSeal Room | 19 Refrigerator Temperature Control Panel |
| 9 Multi Flow | 20 Egg Tray |
| 10 Metal Cover Deoderizer | 21 Door Bin Upper |
| 11 Shelves | 22 Bottle Bins |

Features may vary depending on model. Not all models will have features listed.

BOTTOM MOUNT REFRIGERATOR FEATURES

- EBB2802K-A
- EBB2802K-H

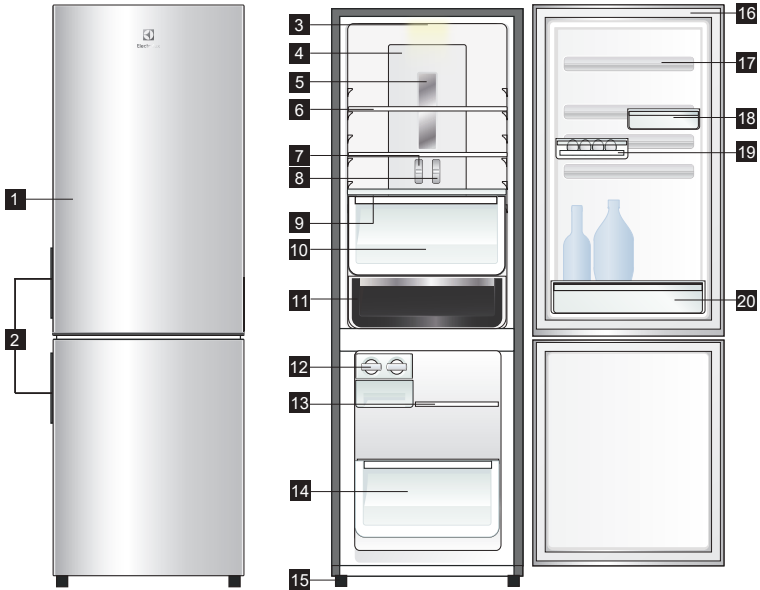

EBB2802 illustrated

The details of the refrigerator feature:

- | | |
|---|--------------------------------|
| 1 Door | 11 TasteSeal Room |
| 2 Door Handles | 12 Ice Twist & Serve |
| 3 Refrigerator Light | 13 Freezer Shelf |
| 4 Multi Flow | 14 Freezer Drawer Lower |
| 5 Metal Cover Deoderizer | 15 Feet |
| 6 Shelves | 16 Gaskets |
| 7 Slide Control Refrigerator Temperature | 17 FlexStor Rails |
| 8 Slide Control Freezer Temperature | 18 FlexStor Bins |
| 9 Humidity Slide | 19 Egg Tray |
| 10 Crisper | 20 Bottle Bin |

Features may vary depending on model. Not all models will have features listed.

BOTTOM MOUNT REFRIGERATOR FEATURES

- EBB3402K-A
- EBB3402K-H



EBB3402 illustrated

The details of the refrigerator feature:

- | | |
|---|--------------------------------|
| 1 Door | 11 TasteSeal Room |
| 2 Door Handles | 12 Ice Twist & Serve |
| 3 Refrigerator Light | 13 Freezer Shelf |
| 4 Refrigerator Temperature Control Panel | 14 Freezer Drawer Lower |
| 5 Multi Flow | 15 Feet |
| 6 Shelves | 16 Gaskets |
| 7 Metal Cover Deoderizer | 17 Door Bin Dairy |
| 8 Slide Control Freezer Temperature | 18 Door Bin Upper |
| 9 Auto Humidity Control | 19 Egg Tray |
| 10 Crisper | 20 Bottle Bin |

Features may vary depending on model. Not all models will have features listed.

BOTTOM MOUNT REFRIGERATOR FEATURES

- EBB3442K-A
- EBB3442K-H

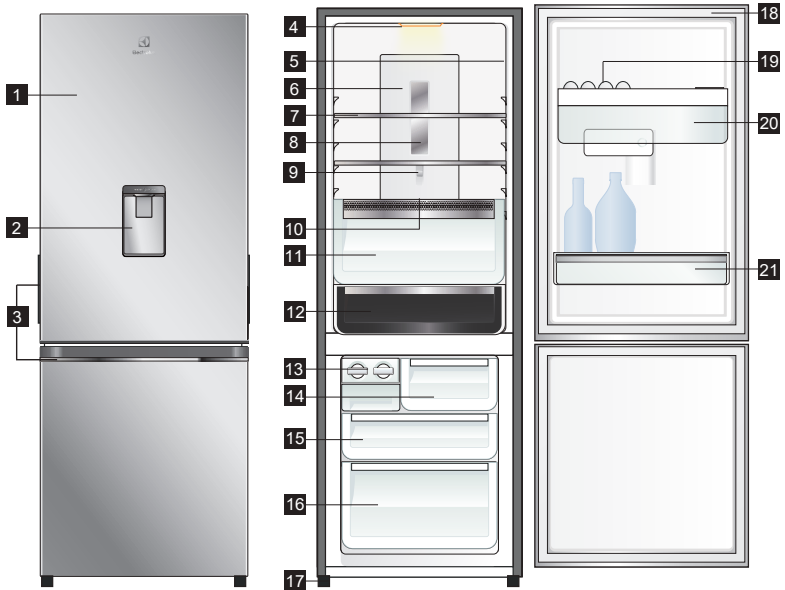

EBB3442 illustrated

The details of the refrigerator feature:

- | | |
|---|--------------------------------|
| 1 Door | 12 TasteSeal Room |
| 2 Water Dispenser | 13 Ice Twist & Serve |
| 3 Door Handles | 14 Drawer meat Box |
| 4 Refrigerator Light | 15 Drawer Middle |
| 5 Refrigerator Temperature Control Panel | 16 Freezer Drawer Lower |
| 6 Multi Flow | 17 Feet |
| 7 Shelves | 18 Gaskets |
| 8 Metal Cover Deoderizer | 19 Egg Tray |
| 9 Slide Control Freezer Temperature | 20 Water Tank |
| 10 Auto Humidity Control | 21 Bottle Bin |
| 11 Crisper | |

Features may vary depending on model. Not all models will have features listed.

BOTTOM MOUNT REFRIGERATOR FEATURES

- EBB3462K-A
- EBB3462K-H



EBB3462 illustrated

The details of the refrigerator feature:

- | | |
|---|--------------------------------|
| 1 Door | 12 TasteSeal Room |
| 2 Water Dispenser | 13 Room Auto Ice Maker |
| 3 Door Handles | 14 Drawer Meat Boxes |
| 4 Refrigerator Light | 15 Ice Bin Small/Large |
| 5 Refrigerator Temperature Control Panel | 16 Freezer Drawer Lower |
| 6 Multi Flow | 17 Feet |
| 7 Shelves | 18 Gaskets |
| 8 Metal Cover Deoderizer | 19 Egg Tray |
| 9 Slide Control Freezer Temperature | 20 Water Tank |
| 10 Auto Humidity Control | 21 Bottle Bin |
| 11 Crisper | |

Features may vary depending on model. Not all models will have features listed.

BOTTOM MOUNT REFRIGERATOR FEATURES

- EBB3702K-A
- EBB3702K-H

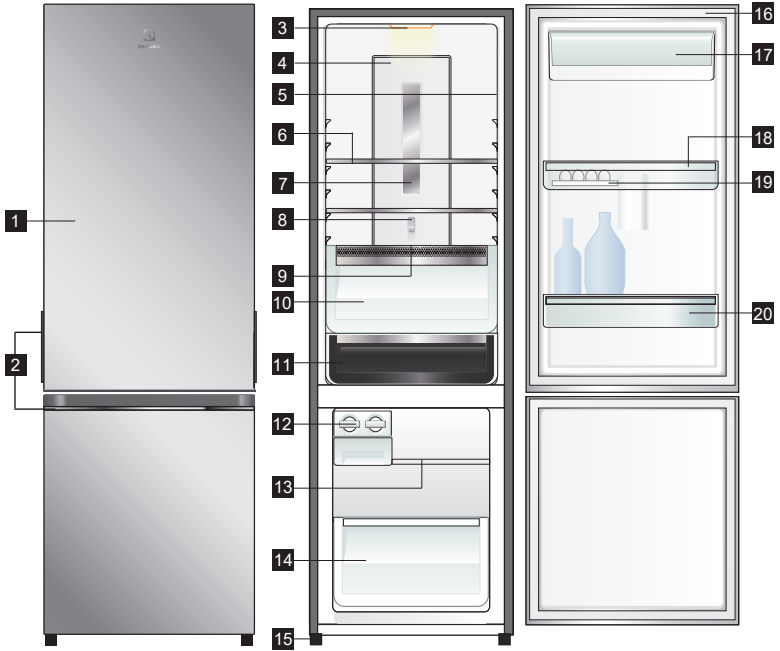

EBB3702 illustrated

The details of the refrigerator feature:

- | | |
|---|--------------------------------|
| 1 Door | 11 TasteSeal Room |
| 2 Door Handles | 12 Ice Twist & Serve |
| 3 Refrigerator Light | 13 Freezer Shelf |
| 4 Multi Flow | 14 Freezer Drawer Lower |
| 5 Refrigerator Temperature Control Panel | 15 Feet |
| 6 Shelves | 16 Gaskets |
| 7 Metal Cover Deoderizer | 17 Door Bin Dairy |
| 8 Slide Control Freezer | 18 Door Bin Upper |
| 9 Auto Humidity Control | 19 Egg Tray |
| 10 Crisper | 20 Bottle Bin |

Features may vary depending on model. Not all models will have features listed.

BOTTOM MOUNT REFRIGERATOR FEATURES

- EBB3742K-A
- EBB3742K-H

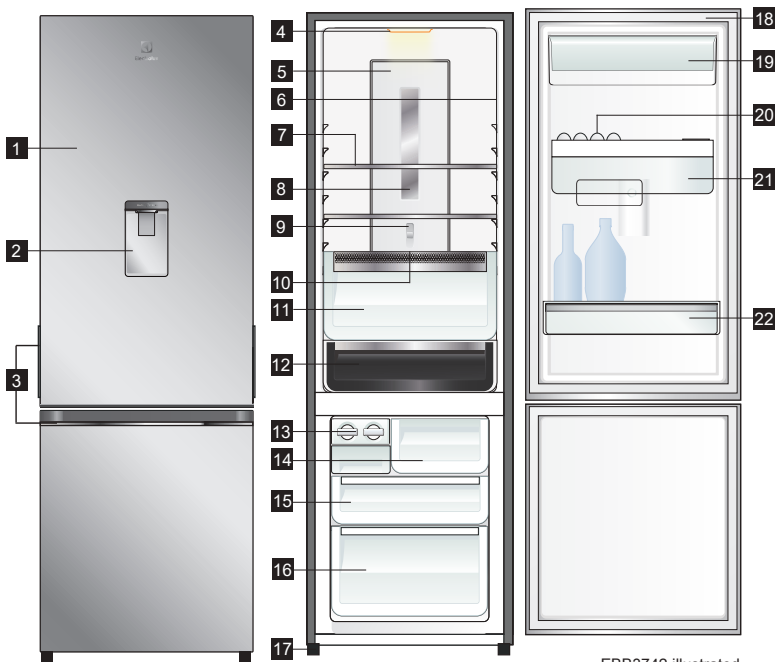

EBB3742 illustrated

The details of the refrigerator feature:

- | | |
|---|---------------------------------|
| 1 Door | 12 TasteSeal Room |
| 2 Water Dispenser | 13 Ice Twist & Serve |
| 3 Door Handles | 14 Freezer Drawer Meat |
| 4 Refrigerator Light | 15 Freezer Drawer Middle |
| 5 Multi Flow | 16 Freezer Drawer Lower |
| 6 Refrigerator Temperature Control Panel | 17 Feet |
| 7 Shelves | 18 Gaskets |
| 8 Metal Cover Deoderizer | 19 Door Bin Dairy |
| 9 Slide Control Freezer Temperature | 20 Egg Tray |
| 10 Auto Humidity Control | 21 Water Tank |
| 11 Crisper | 22 Bottle Bin |

Features may vary depending on model. Not all models will have features listed.

BOTTOM MOUNT REFRIGERATOR FEATURES

- EBB3762K-A
- EBB3762K-H

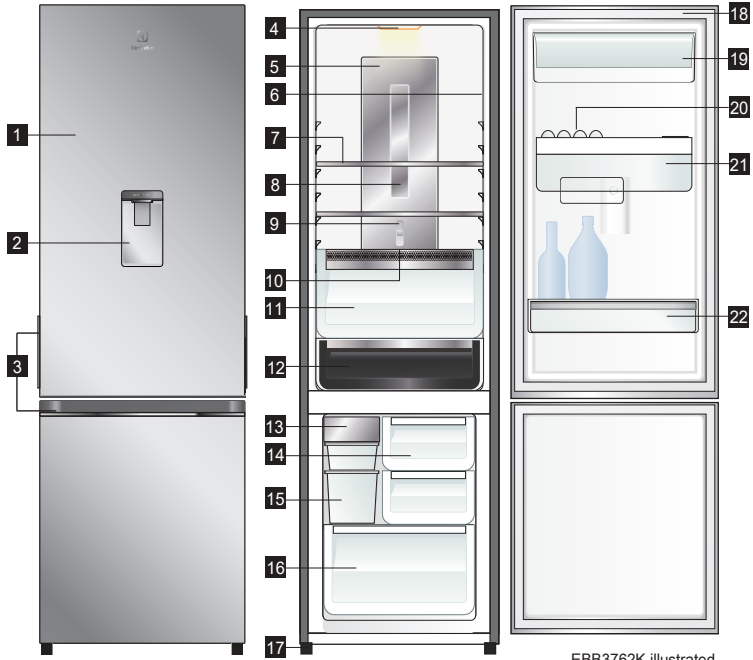

EBB3762K illustrated

The details of the refrigerator feature:

- | | |
|---|--------------------------------|
| 1 Door | 12 TasteSeal Room |
| 2 Water Dispenser | 13 Auto Ice Maker |
| 3 Door Handles | 14 Drawer Meat Boxes |
| 4 Refrigerator Light | 15 Bin Ice Small/Large |
| 5 Multi Flow | 16 Freezer Drawer Lower |
| 6 Refrigerator Temperature Control Panel | 17 Feet |
| 7 Shelves | 18 Gaskets |
| 8 Metal Cover Deoderizer | 19 Door Bin Dairy |
| 9 Slide Humid Freezer Temperature | 20 Egg Tray |
| 10 Auto Humidity Control | 21 Water Tank |
| 11 Crisper | 22 Bottle Bin |

Features may vary depending on model. Not all models will have features listed.

3. CONTROL PANEL.

3.1 TEMPERATURE CONTROL

When you first turn on the refrigerator, set both the refrigerator and freezer temperature control to normal. Please refer to the below section for information on adjusting refrigerator and freezer temperature.

i When you set a temperature, you set an average temperature for the whole refrigerator cabinet.

Checking the softness of ice cream is a good indication that your freezer is the right temperature, while checking the temperature of water kept in the refrigerator is a good way of checking the temperature of the food compartment.

Temperatures inside each compartment may vary, depending on how much food you store and where you place it.

High or low room temperature may also affect the actual temperature inside the refrigerator.

When you change the temperature settings, make small adjustments and wait 24 hours before assessing whether you need to make any further changes.

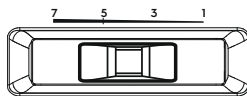
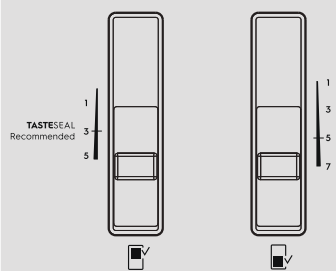
DESCRIPTION	OPERATION / PRIMARY FUNCTION
<p>Top mount</p> 	<p>Freezer temperature adjustment.</p> <ul style="list-style-type: none"> - Select the freezer control. - Slide the control to the left to set it to colder (No.7). - Slide the control to the right to set less cold (No.1).
<p>Bottom mount freezer</p>  <p>Refrigerator Freezer</p>	<p>Refrigerator temperature adjustment.</p> <ul style="list-style-type: none"> - Select the refrigerator control. - Slide the control down to set it to colder (No.5). - Slide the control up to set less cold (No.1). <p>Freezer temperature adjustment.</p> <ul style="list-style-type: none"> - Select the freezer control. - Slide the control down to set it to colder (No.7). - Slide the control up to set less cold (No.1).

Recommended Freezer Setting

Room Temp.	Setting
Below 15°	7
Above 15°	5

Only install refrigerator indoors where the room temperature is above 10°

i Setting the freezer temperature to colder is not recommended for normal or very hot climate condition as this will limit the cooling capacity to other sections of the refrigerator. In very cold climate the freezer will need to be set colder.

3.2 ABOUT THE USER INTERFACE

- ETB3400K-A • ETB3700K-A • EBB3402K-A • EBB3702K-A
- ETB3400K-H • ETB3700K-H • EBB3402K-H • EBB3702K-H
- ETB3440K-A • ETB3740K-A • EBB3442K-A • EBB3742K-A
- ETB3440K-H • ETB3740K-H • EBB3442K-H • EBB3742K-H

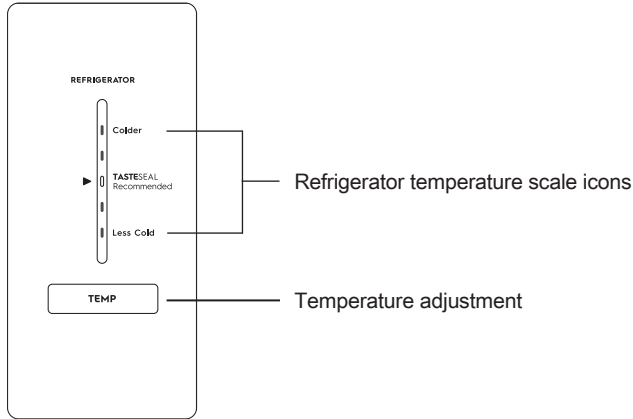

DESCRIPTION	OPERATION / PRIMARY FUNCTION
Refrigerator temperature scale icons	<ul style="list-style-type: none"> Indicates the temperature setting of the refrigerator compartment.
Temperature adjustment	<p>Temperature Control</p> <ul style="list-style-type: none"> Touch the 'TEMP' button to awaken control. Touch the 'TEMP' button to decrease the refrigerator temperature. There are 5 temperature settings indicated by the illumination sequence on the display. Once the coldest temperature is reached the display will return to the warmest setting with the next press.

ABOUT THE USER INTERFACE

- ETB3460K-A
- EBB3462K-H
- EBB3462K-A
- EBB3462K-H
- ETB3760K-A
- ETB3760K-H
- EBB3762K-A
- EBB3762K-H

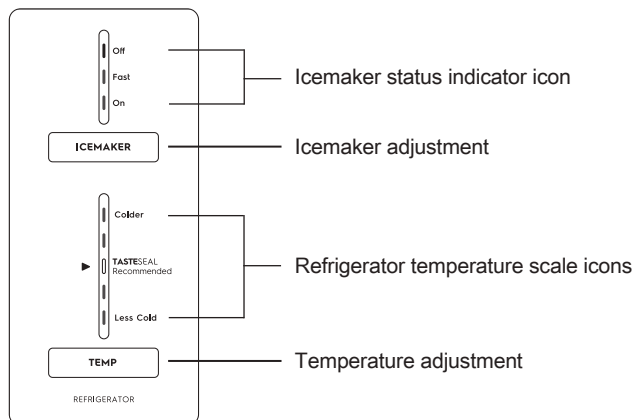

DESCRIPTION	OPERATION / PRIMARY FUNCTION
Icemaker status indicator icon	<ul style="list-style-type: none"> Show operation status.
Icemaker adjustment	<ul style="list-style-type: none"> This button selects the status of ice maker. (On, Off and activate Fast Ice)
Refrigerator temperature scale icons	<ul style="list-style-type: none"> Indicates the temperature setting of the refrigerator compartment.
Temperature adjustment	<p>Temperature Control</p> <ul style="list-style-type: none"> Touch the 'TEMP' button to awaken control. Touch the 'TEMP' button to decrease the refrigerator temperature. There are 5 temperature settings indicated by the illumination sequence on the display. Once the coldest temperature is reached the display will return to the warmest setting with the next press.

3.3 ERROR CODE & ALARMS

ERROR CODES

ERROR CODE	WHAT IT MEAN ...	WHAT TO DO ...
<p>Communication error</p> <p>LED_5 flashes with 1sec interval</p> 	<p>If you see the top temperature icon is flashing it means that the control has lost contact with the main control board.</p> <p>The appliance will operate at its last known setting, all auxiliary functions will not work.</p>	<p>Turn the unit off at the electric outlet for 5 minutes and then turn it back on.</p> <p>Under most circumstances this will reset the display enabling normal function to continue.</p> <p>If the error re-occurs then call for service.</p>

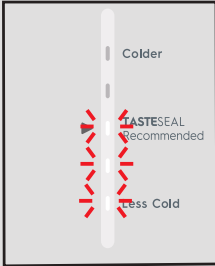
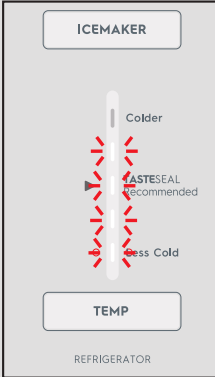
<p>Sensor – Open Circuit / Short Circuit</p> <p><u>Non-icemaker</u></p> 	<p>If you see any combination of the first, second and third icons are flashing it means that an error has been detected on a sensor.</p> <p>The refrigerator will run in a default cycle to prevent food spoilage.</p>	<p>Call for service.</p>
<p><u>With icemaker</u></p> 	<p>If you see any combination of the first, second, third and fourth and all temperature icons are flashing it means that an error has been detected on a sensor.</p> <p>The refrigerator will run in a default cycle to prevent food spoilage.</p>	<p>Call for service.</p>

ALARMS

ALARM ICON	WHAT IT MEANS	OPERATION
------------	---------------	-----------

Non-icemaker

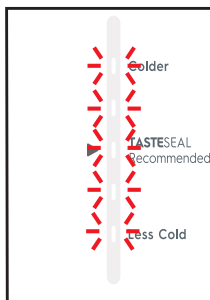

Activates if the refrigerator or freezer doors are left open for longer than 2 minutes.

An alarm will sound and the affected compartment icon will flash and the temperature and icons will fade on and off.

Alarm will sound and icon will flash indicating which door is open.

To silence the alarm for 8 minutes while the door is open press any button (the icons will continue to flash until door is closed).

With icemaker

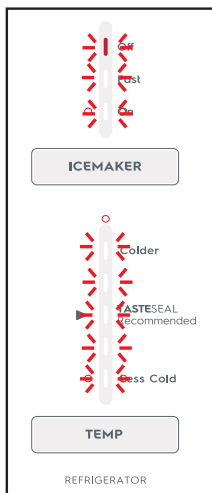

Activates if the refrigerator or freezer doors are left open for longer than 2 minutes.

An alarm will sound and the affected compartment icon will flash and the temperature and icons will fade on and off.

Alarm will sound and icon will flash indicating which door is open.

To silence the alarm for 8 minutes while the door is open press any button (the icons will continue to flash until door is closed).

4. INSTALLING YOUR NEW APPLIANCE

Clean the refrigerator thoroughly according to instruction, and wipe away any dust that has accumulated during shipping.

Check that the floor is level. If it is not then adjust the provided leveling leg so product is level and stable.

We recommend that you let your refrigerator run for two to three hours before you put any food in it. This will allow you to check that it is operating properly and that enough cool air is going to the freezer.

Clearance around your Top and Bottom Mount refrigerator;

- Allow a minimum of 30mm clearance on both sides of the refrigerator.
- Allow 50mm clearance at the back of the refrigerator.
- Allow a minimum of 10mm clearance above the hinge cover.
- If you do not have a cupboard with allowance for air flow above the refrigerator, the recommended clearance area on top increases to 90 mm.
- When positioned in a corner area, spacing of at 350mm on the hinge side will allow the doors to open enough to enable the removal of bins and shelves.

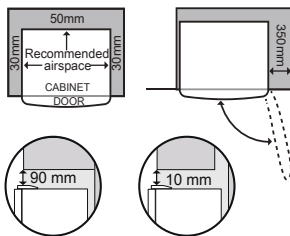

NOTE: In installation where both sides and the rear of the refrigerator are not enclosed by cabinetry e.g. the refrigerator is placed against a wall, the clearance between the rear of refrigerator and the wall should not be greater than 75mm.

Your refrigerator uses energy efficient components that may produce different noises (Refer "Noises" page for examples) to your old refrigerator. Occasionally a gurgling sound of refrigerator flowing or the sound of parts expanding and contracting can be heard. These noises are quite normal.

Installing your refrigerator

1. Roll the refrigerator into place, the rollers are designed for forward or backward movement only, they are not castors. Moving the refrigerator sideways may damage your floor and the rollers. Before moving your refrigerator, ensure height adjusting nut and the stability foot are fully wound up off the floor.
2. Wind the height adjusting nut under door hinge down until the refrigerator is tilted back by 10mm (see diagram).

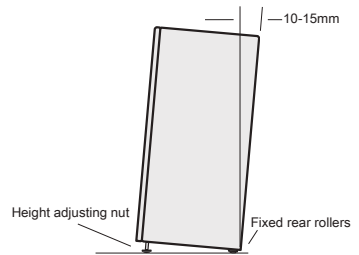

3. Wind the height adjusting nut on the handle side down until the refrigerator is level and stable. If you have difficulty winding the nut or height adjusting foot down, have someone tilt the refrigerator back so you have better access.

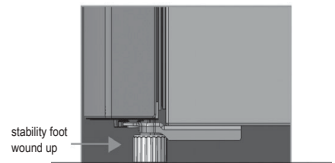

4. Check the alignment of the refrigerator to the surrounding cupboards to see if it is level. You can adjust the level as detailed in step 2 and 3.

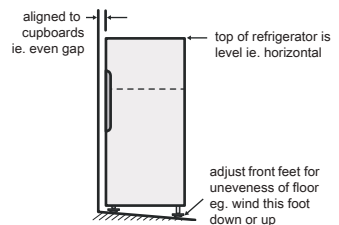

5. USING YOUR REFRIGERATOR

Refrigerators work by transferring heat from the food inside to the outside air. This operation makes the back and sides of the refrigerator feel warm or even hot particularly at start-up and on warm days – this is normal.

Avoid placing food against the air vents in the refrigerator as it affects efficient circulation. If the door is opened frequently, a light frosting will occasionally occur on the freezer's interior. This is normal and will clear after a few days. If the freezer door is accidentally kept open, a heavy frost will coat the inside walls and should be removed.

Your new refrigerator uses a high-speed compressor, along with other energy-efficient components, which may make unusual sounds and be more noticeable at night and quieter times. These sounds simply indicate your refrigerator is working how it should. They include:

- Compressor running noises; modern, high-efficiency compressors run much faster than older models.
- Air movement noise from the small fan motor;
- A gurgling sound, similar to water boiling;
- A popping noise, heard during automatic defrosting; and
- A clicking noise, prior to compressor start-up. Further details can be found in the Troubleshooting Guide.
- Automatic icemaker, while icemaker producing ice sounds of ice cubes falling in to ice bin pumping and/or water filling may be heard.

i For bottom mount refrigerators (where freezer is below the fresh food compartment):

- Ensure all freezer drawer and shelves are pushed back completely to prevent them from keeping the door open.



For top mount refrigerators (where the freezer is on top of the fresh food compartment).

- Don't place food forward of the ribs on the freezer floor, as it will obstruct the door from closing.

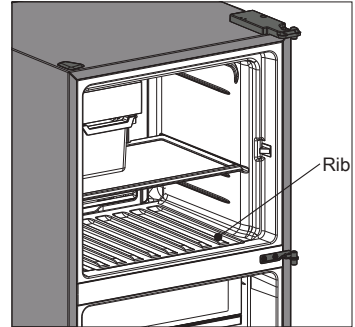

5.1 USING AND REMOVING FEATURES

5.1.1 TasteSeal Room

Use the TasteSeal compartment to store meat, snack, beverage and dairy products. You can adjust TasteSeal temperature by adjusting the refrigerator temperature control.

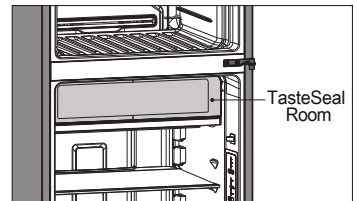

5.1.2 Metal Tray (Option for ETB3** and EBB3** models)

Metal tray locate in TasteSeal room and can lift off from plastic body for cleaning follow to instruction in this manual. Avoid direct contact with food stuff that contain high acid or alkali and clean it immediately when found any stain.



CAUTION

Do not use in hot cooking or oven cooking stoves.

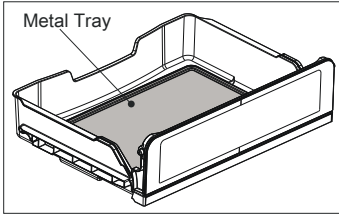

5.1.3 Glass Shelves

To remove the shelves, gently pull them forward until the shelf comes clear of the shelf guides.

To return the shelf, make sure there is nothing behind that may obstruct movement. Gently push the shelf, into the cabinet and back into position.

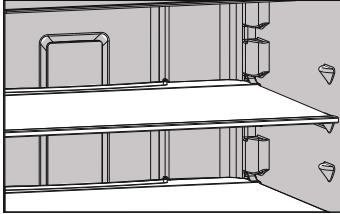

5.1.4 Deodorizer

Your refrigerator is fitted with Deodorizer to assist with the removal of food odours inside your refrigerator. Keeping the food covered and wrapping it in plastic will also help to reduce the odours inside your refrigerator.

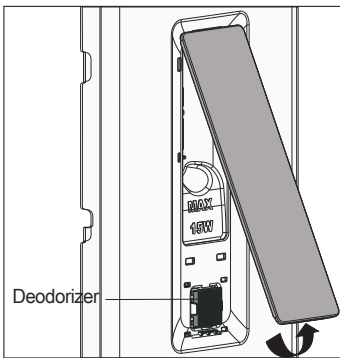

5.1.5 Crisper Drawer

Crisper drawer is designed for storing fruits, vegetables, and other fresh produce. Crisper have an auto humidity membrane in front of crisper cover to maintain optimum humidity for longer fresh vegetables.

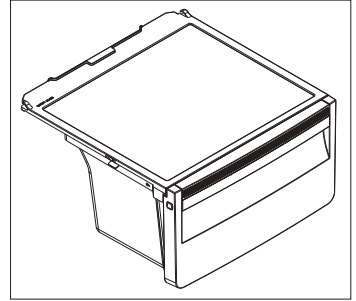

- To empty food from the crisper. On some models it will be necessary to remove the bottle storage bins.
- Remove the crisper by pulling forward, then up and forward again.
- For top mount models, remove the crisper shelf by lifting the catches on the left and right underside of the shelf and pulling the shelf forward.

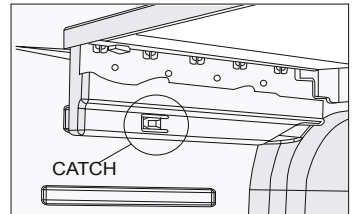

Auto humidity membrane automatically releases excess moisture and maintains optimal humidity for your fresh vegetables, maintaining the taste, texture and freshness.

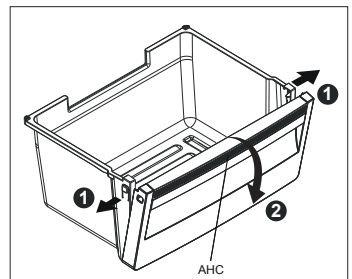

To remove the Auto humidity membrane part follow these step:

1. Unclip the both side clips and,
2. Lift off from crisper drawer.



It's not required to replace the Auto humidity membrane unless it becomes damaged or ruined. If the membrane becomes soiled or dirty, it can be washed with soap and water. Ensure membrane is dry before putting back in crisper drawer. Please contact our service provider when need to replace your AHC membrane.

5.1.6 Crisper bin

- Storing Vegetables Use the crisper bin to store vegetables, fruits or small items. You can adjust the humidity inside the bin by sliding the humidity control. Model ETB2** and EBB2** have slide control.

5.1.7 Door storage bins

Both the refrigerator and freezer have door storage bins.

You can adjust the refrigerator bins to meet different storage needs. All the door bins are completely removable for cleaning. If you want to remove or adjust a bin, lift and unlock from lugs to remove. To replace, lift up and push bin down until the support lugs lock it in place.

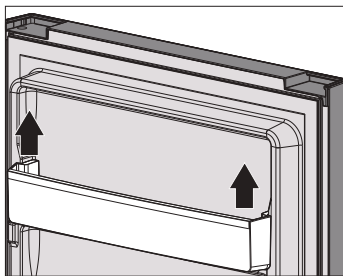

5.1.8 Water Tank



CAUTION
BEFORE REMOVE; to empty the water in the tank.

To remove the water tank and disassembly cleanable parts follow these steps:

1. Press 2 clips on side of water tank to unlock water tank from lugs and hold on the tank.
2. Pull out the water tank.

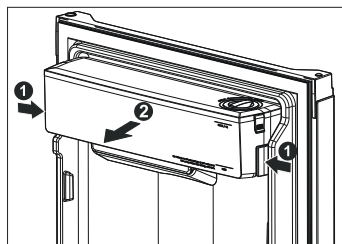

3. Rotate tank cover lid up and off from the cover.
4. Unclip the both side clips and lift off from water tank.
5. Screw the water valve off from tank.

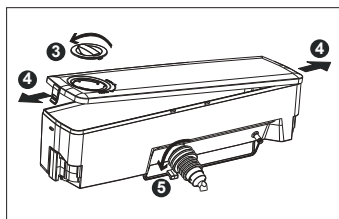

6. Remove nozzle rubber and o-ring from water valve.

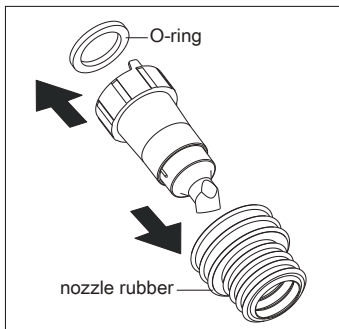

Reverse the step to assembly the water tank and return to its place.

NOTE: Screw in the water valve to water tank till stopper touch the rip and the water valve nozzle must be point down as picture.

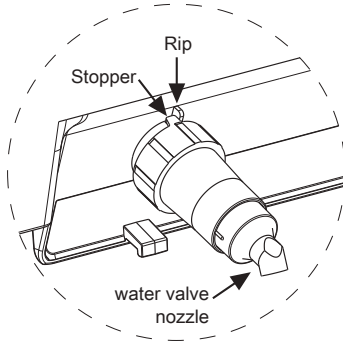

CAUTION

LED lighting

Your appliance is fitted with long life LED lighting. In the unlikely event the LED lights should fail, then the LED lights should be serviced by the manufacturer.

Refer to the warranty page for contact details.

6. Automatic Ice Maker

The automatic ice making function pumps water from the water tank located in the refrigerator and dispenses it into the automatic ice maker in the freezer.

The ice will then be dropped into the ice bin located beneath the ice maker. If the water tank is empty or lower than level, the ice maker will automatically turn off after 3 attempts at pumping water from the tank. The ice maker indicator on the user interface shows the operational status of the ice maker (Refer control instructions).

In case water tank is empty and ice maker show "off" status with red light, you simply can fill up water and just have to select "ICEMAKER" to be "on" again to turn on ice maker to continuous making ice.

Water Tank Refilling

Step 1. Open the tank cover lid up and off from the cover.

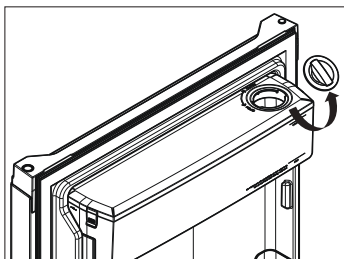

Step 2. Pour potable water through the lid at the top of the water tank.

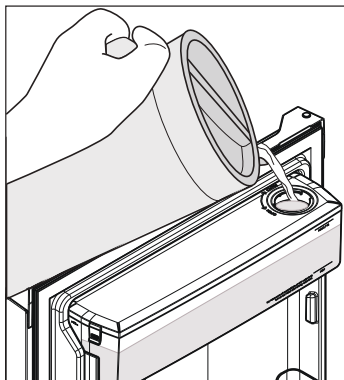

Step 3. Closed the tank cover lid.

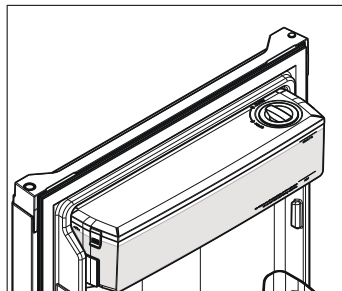

CAUTION

Do not fill the water tank with anything other than clean water (Filtered or Mineral water), soft drink, juice, tea or hot water etc, can damage your automatic icemaker. The water tank can withstand a maximum water temperature of 60°C.



Tips and Useful Information

Remove and clean ice bin and water tank once a month, discarding unused ice and water. This will ensure fresh ice and smooth operation of your icemaker. Make sure your refrigerator is level to avoid uneven ice cubes.

It is recommended to always keep water level filled above the "Min" level indication to have water ready for your chilled drinks, and ready for ice making.

It is recommended to dispense water out in first few glasses and/or ice production to flush out the system or any impurities in first time use or after installation.

7. CLEANING YOUR REFRIGERATOR



WARNING

BEFORE CLEANING: Turn the refrigerator off at the electric outlet and unplug the cord to prevent any chance of electrocuting yourself.

Doors and exterior (white and silver):

You should only clean the doors with lukewarm soapy water and a soft cloth.



CAUTION

Never use stainless steel cleaners, abrasive pads or other cleaners that will scratch the surface. Damage to the appliance after delivery is not covered by your warranty.

Interior

Clean the inside of your refrigerator regularly with a soft cloth, unscented mild soap and lukewarm water.

Thoroughly dry all surfaces and removable parts and avoid getting water on the controls. Replace removable parts, plug power cord in and switch the power on before returning the food.

Water Tank Assembly

Clean the inside of the water tank regularly with a soft cloth, unscented mild soap and rinse thoroughly with lukewarm water to completely remove any soap residue.

Door seals

Always keep door seals clean by washing them with a mild detergent and warm water, followed by a thorough drying.

Sticky food and drink can cause seals to stick to the cabinet and tear when you open the door.



CAUTION

Never use hot water, solvents, commercial kitchen cleaners, aerosol cleaners, metal polishes, caustic or abrasive cleaners, or scourers to clean your refrigerator. Many commercially available cleaning products and detergents contain solvents that will damage your refrigerator. Use only a soft cloth with an unscented mild soap and lukewarm water.

To clean a crisper or freezer bin with telescopic extension slides, simply wipe with a damp cloth and warm soapy water. Never immerse the cover in water, as this could affect the operation of the slide.

Switching off your refrigerator

If you switch off your refrigerator for an extended period, follow these steps to reduce the chances of mould:

1. Remove all food.
2. Remove the power plug from the electric outlet.
3. Thoroughly clean and dry the Interior.
4. Ensure that all the doors are wedged open slightly for air circulation.

8. FOOD STORAGE GUIDE

CATEGORY	PRODUCT	REFRIGERATOR	FREEZER	STORAGE TIPS
Meat	Sausages and Mince	1-2 Days	2-3 Months	Keep cold meat at the back of the refrigerator where it is coldest.
	Chops and Steak	3-4 Days	4-6 Months	Plastic can cause meat to sweat if stored in refrigerator for more than a day.
	Cold Meats	3-5 Days	4-6 Months	Roast can take up to 48 hours to defrost properly, transfer frozen roast to the refrigerator 2 days before use.
	Roasts	3-5 Days	12 Months	
Poultry	Chicken	1-2 Days	2 Months	If poultry takes on a smell or colour you are unsure about it is best to throw it out.
	Roast Chicken	3-5 Days	12 Months	
	Eggs	6 Weeks	Not Suitable	Whole eggs are not suitable for freezing, slightly beaten eggs may be frozen for four months.
Seafood	Whole fish and fillets	2-3 Days	2 Months	Store in an airtight container or foil.
	Lobster and crabs	1-2 Days	2 Months	
	Prawns	1-2 Days	2 Months	Never freeze prawns in salty water as this will dehydrate the flesh.
Dairy	Milk	7-10 Days	Not Suitable	If dairy takes on a smell or colour and you are unsure about it, it is best to throw it out.
	Yoghurt	7-10 Days	Not Suitable	
	Hard Cheeses	2 Weeks – 2 Months	2 Months (Grated)	Depending on the variety hard cheese can last from 2 weeks to 2 months.
	Soft Cheeses	1-2 Weeks	Not Suitable	
	Butter	8 Weeks	12 Months	
Fruit & Vegetables	Every fruit and vegetable has a different shelf life. Some stay fresh for a couple of days e.g beans, others can last for a couple of months e.g. onions.		8-12 Months	Keep vegetables in the crisper and away from the air vents to avoid freezing.
			When freezing chop and blanch in small portions.	
Left Overs	Homemade meals	3-4 Days	2-6 Months	Store in sealed container.
				Freeze meals in small portion sizes to limit wastage.



IMPORTANT

Please note, use this information as a guide only, actual storage times will vary depending on how you use your refrigerator, climatic conditions and the freshness of the food.

9. TROUBLESHOOTING

Appliance does not operate at desired temperature

In a modern frost free refrigerator / freezer, cold air is circulated around the various compartments through air vents using a high efficiency fan.

CONCERN	WHAT TO DO
Refrigerator is too warm.	<p>Ensure food is allowed to cool before placing inside the refrigerator.</p> <p>Ensure the appliance is set up as per instructions.</p> <p>Ensure that contents are not obstructing the cooling vents.</p> <p>Ensure the door is not held open or is being opened too frequently.</p>
Freezer is too warm.	<p>Adjust temperature to a colder setting.</p> <p>Ensure food is allowed to cool before placing inside the freezer.</p> <p>Ensure the appliance is set up as per instructions.</p> <p>Ensure that contents are not obstructing the cooling vents.</p> <p>Ensure the door is not held open or is being opened too frequently.</p>
Food is freezing in the refrigerator.	<p>Adjust temperature to a warmer setting.</p> <p>Ensure that fruits and vegetables are stored in the crisper. Items with a high water content should not be placed near the cooling vents.</p>
Unable to change temperature settings.	<p>Refer to function guide in Controlling Your Refrigerator.</p> <p>Ensure that user interface is in "awake" mode before trying to adjust temperature settings.</p>

Appliance noise

Your new refrigerator may make sounds that your old one didn't make. Because the sounds are new to you, you might be concerned about them. Most of the new sounds are normal. Hard surfaces, like the floor, walls and cabinets, can make the sounds seem louder than they actually are. The following describes the kinds of sounds and what may be making

CONCERN	WHAT TO DO
Motor noise (compressor)	<p>Nothing. This is normal as your new refrigerator uses a variable speed compressor and fan that at start up and on warm days runs at a high speed to provide additional cooling.</p> <p>When less cooling is required the compressor and fan will run at a lower speed.</p> <p>Note that the compressor noise may seem louder at the start of the on cycle.</p>
A clicking noise heard just before the compressor starts	Nothing. This is normal as your new refrigerator has an automatic switching action of the temperature control, turning the compressor on and off.
Occasional gurgling, similar to water boiling	Nothing. As each refrigeration cycle ends, you may hear a gurgling sound due to the refrigerant flowing in your refrigerator system.
Airflow noise	Nothing, this is normal as your new refrigerator uses high efficiency fans to circulate air. Fan speed and noise may increase during periods of heavy usage or hot weather.
Rattling and other noises	<p>Ensure that the cabinet is level and stable, refer to Installation Instructions.</p> <p>Check the surroundings of the appliance to ensure there is nothing touching or placed on top of the appliance.</p> <p>Ensure that contents of the appliance are not placed in such a way that they are vibrating (such as bottles).</p>

Refrigerator operation

CONCERN	WHAT TO DO
<p>Appliance will not run It is normal for the freezer fan not to operate during the automatic defrost cycle, or for a short time after the appliance is switched on.</p>	<p>Ensure that the cord is plugged into a live power outlet and outlet is switched on. Ensure that the household circuit breaker has not tripped or that the fuse has not blown. The appliance maybe in defrost mode, check again in half an hour.</p>
<p>Compressor motor seems to run too long At normal room temperatures, expect your motor to run about 40% to 80% of the time. Under warmer conditions, expect it to run even more often.</p>	<p>Ensure that the doors are not held open Check that large amounts of warm food have not just been placed inside the appliance. Note that the appliance will run more than normal just after you install it or when adjusting to temperature setting changes.</p>
<p>The exterior of the appliance is warm or hot to touch This is normal because the appliance transfers heat from the inside out through the outer panels and the divider between the doors.</p>	<p>Ensure the appliance has the external clearances recommended in the section "Installing your new appliance". The exterior of the cabinet will be much warmer on warmer days it may even feel hot to touch, as the appliance is working harder.</p>
<p>User interface will not respond To ensure settings are not accidentally changed the user interface will go into sleep mode when not in use. Press any button to wake user interface</p>	<p>Check that the user interface is in awake mode, refer to section "About the user interface". If the user interface is frozen turn the appliance off for five minutes for the memory to clear, then turn back on.</p>
<p>Alarms Sounding Alarm activates if the refrigerator or freezer doors are left open for longer than 2 minutes.</p>	<p>Check that all doors are fully closed. To silence the alarm for 8 minutes while the door is open press any button on user interface or close the door.</p>
<p>Frost build up</p>	<p>Check that all doors are fully closed. Ensure that the doors are not opened too often. Ensure that the return air vents are not blocked with packaging. Ensure the seals are clean and not obstructed.</p>
<p>Odours</p>	<p>The interior may need cleaning, refer to cleaning guide. Ensure that food is stored correctly as some food, containers and wrapping can produce odours. Check appliance for old or unusual food.</p>
<p>Lights not working The LED lighting is designed to dim automatically if the door is left opened for more than 5 minutes and turn off completely if the door is open for more than 7 minutes. Closing the door will reset the timer. The LED lighting is also designed to turn on gradually.</p>	<p>Ensure that the cord is plugged into a live power outlet and outlet is switched on. Ensure that the household circuit breaker has not tripped or that the fuse has not blown.</p>

Crisper operation

CONCERN	WHAT TO DO
<p>Excess moisture build up in crisper</p> <p>It is normal for there to be some moisture and humidity in the crisper bin.</p>	<p>Ensure that the crisper is not over packed.</p>
<p>Crisper bin can not be removed</p>	<p>If crisper bin interferes with the door bins, remove door bins before removing crisper. Position cabinet so that the door can be fully opened.</p>
<p>Freezing items in the crisper</p>	<p>Adjust temperature to a warmer setting.</p>

Automatic Ice maker system

CONCERN	WHAT TO DO
<p>Ice maker does not produce ice or not enough ice</p>	<p>Ensure that the Ice Maker is switched on at the user interface refer to "About the User Interface" for details.</p> <p>Ensure water tank is full and contains clean water (if liquids other than clean water have been used, call Electrolux Customer Care).</p> <p>Ensure water tank is securely pushed into pump housing.</p>
<p>The icemaker is designed to produce a tray of ice approximately every 2 hours, depending on the conditions.</p>	<p>If the freezer compartment is too warm, refer to "freezer is too warm" then wait 24 hours for the freezer to reach ideal temperature.</p> <p>Turn the unit off at the mains and leave for 2 minutes then turn the appliance back on (this will reset the icemaker unit). Check for ice production after 24 hours.</p> <p>Check that there is no obstruction under the ice maker and ensure the ice bin is fitted correctly.</p>
<p>Ice has bad odour or taste</p>	<p>Cover food to ensure ice does not absorb foreign odours.</p> <p>Interior of appliance or ice bin may require cleaning, refer to "Cleaning your refrigerator".</p> <p>Discard stale ice monthly and allow ice maker to produce a fresh supply.</p>

If you still require service

If you have a problem, and the problem persists after you have made the checks mentioned, contact your nearest Electrolux approved Service Centre or the dealer you bought the refrigerator from. Be ready to quote the model number, the 9-digit PNC and 8-digit serial number, which is stated on the label inside the refrigerator compartment.

10. NOISES

Appliance noise

Your new refrigerator may make sounds that your old one didn't make. Because the sounds are new to you, you might be concerned about them. Most of the new sounds are normal. Hard surfaces, like the floor, walls and cabinets, can make the sounds seem louder than they actually are. The following describes the kinds of sounds and what may be making them.

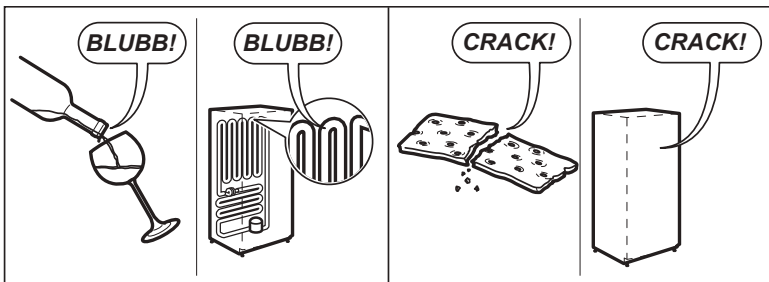
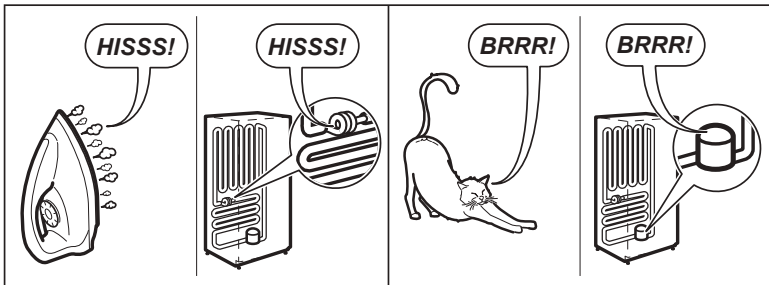
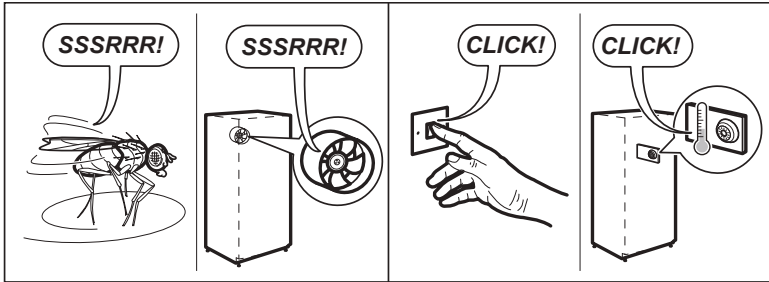
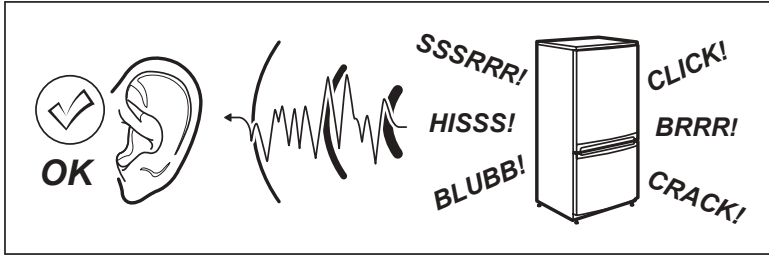

www.electrolux.com/shop



A12081659-A-492020

